

Leica GPS1200 System Field Manual



Version 5.0
English

- when it has to be **right**

Leica
Geosystems

Introduction

Purchase

Congratulations on the purchase of a GPS1200 Series instrument.



To use the product in a permitted manner, please refer to the detailed safety directions in the User Manual.

Product identification

The type and the serial number of your product are indicated on the type plate. Enter the type and serial number in your manual and always refer to this information when you need to contact your agency or Leica Geosystems authorized service workshop.

Type: _____

Serial No.: _____

Symbols

The symbols used in this manual have the following meanings:

Type	Description
	Important paragraphs which must be adhered to in practice as they enable the product to be used in a technically correct and efficient manner.

Trademarks



- Windows and Windows CE are a registered trademark of Microsoft Corporation
 - CompactFlash and CF are trademarks of SanDisk Corporation
 - Bluetooth is a registered trademark of Bluetooth SIG, Inc
- All other trademarks are the property of their respective owners.

Validity of this manual

- This manual applies to all GPS1200 instruments. Differences between the various models are marked and described.
- The RX1200 is available as RX1210 or with touch screen functionality as RX1210T, RX1250X, RX1250Xc, RX1250T or RX1250Tc. The name RX1210 is used throughout the manual and may also represent the touch screen models. Only use the supplied stylus on the screens of the touch screen models.
- This manual covers standard real-time surveying applications. Refer to the GPS1200 Technical Reference Manual for information about other functionality available.

Available documentation

Name	Description	Format	
User Manual	All instructions required in order to operate the product to a basic level are contained in the User Manual. Provides an overview of the product together with technical data and safety directions.	X	X

Name	Description	Format	
			
System Field Manual	Describes the general working of the product in standard use. Intended as a quick reference field guide.	-	x
Application Programs Field Manual	Describes specific onboard application programs in standard use. Intended as a quick reference field guide. The Road-Runner application program is described in a separate manual.	xx	
Technical Reference Manual	Overall comprehensive guide to the product and program functions. Included are detailed descriptions of special software/hardware settings and software/hardware functions intended for technical specialists.	-x	

Refer to the following resources for all GPS1200 documentation and software:

- the SmartWorx DVD
- <http://www.leica-geosystems.com/downloads>

Table of Contents

In this manual

Chapter	Page
1 User Interface	7
1.1 Keyboard	7
1.2 Screen	9
1.3 Operating Principles	10
1.4 Icons	13
1.5 Symbols	19
2 Equipment Setup	21
2.1 Receiver Ports	21
2.2 Post-Processed Static Reference on Pillar	22
2.3 Real-Time Reference, Single Tripod	23
2.4 Real-Time Reference using SmartAntenna, RX1250 and GHT56	24
2.5 SmartRover - External Radio	25
2.6 Real-Time Rover, Pole and Minipack	26
2.7 Real-Time Rover, All-on-Pole	28
3 Determining Antenna Heights	29
4 Using RX1250	31
4.1 Switching between Leica software and Windows CE desktop	31
4.2 Sleep Mode	32
4.3 Interface Configuration	33
4.3.1 Overview	33
4.3.2 Configuring SmartAntenna Interface	34
4.3.3 Configuring Clip-On Interface	35
5 Receiver Protection with PIN	37
6 Manage... - Getting Started	39
7 Manage...\Jobs	43
7.1 Overview	43
7.2 Creating a New Job/Editing a Job	44
8 Manage...\Data	47
8.1 Overview	47
8.2 Point Management	48
8.2.1 Creating a New Point/Editing a Point	48
8.2.2 Mean Page	52
8.3 Line/Area Management	55
8.3.1 Overview	55
8.3.2 Creating a New Line/Area/Editing a Line/Area	56
8.4 Point Sorting and Filters	59
8.4.1 Sorting and Filters for Points, Lines and Areas	59
8.4.2 Point, Line and Area Code Filter	61
9 Manage...\Codelists	63
9.1 Creating a New Codelist/Editing a Codelist	63
9.2 Creating a New Code/Editing a Code	64

10	Linework	67
	10.1 Performing Linework	67
	10.2 Combining Linework and Coding	70
11	Manage...\Coordinate Systems	73
	11.1 Overview	73
	11.2 Creating a New Coordinate System/Editing a Coordinate System	74
	11.3 Transformations/Ellipsoids/Projections	76
	11.3.1 Accessing Transformation/Ellipsoid/Projection Management	76
	11.3.2 Creating/Editing a Transformation/Ellipsoid/Projection	77
	11.4 Geoid/GSCS Models	79
12	Manage...\Configuration Sets	81
	12.1 Overview	81
	12.2 Creating a New Configuration Set	82
	12.3 Editing a Configuration Set	83
13	Manage...\Antennas	85
	13.1 Overview	85
	13.2 Creating a New Antenna/Editing an Antenna	86
14	Convert...\Export Data from Job	89
	14.1 Overview	89
	14.2 Exporting ASCII Data	90
15	Convert...\Import Data to Job	93
	15.1 Overview	93
	15.2 Importing ASCII/GSI Data	94
	15.3 Importing DXF Data	96
16	Convert...\Copy Points Between Jobs	97
17	Config...\Survey Settings...	99
	17.1 ID Templates	99
	17.1.1 Overview	99
	17.1.2 Creating a New ID Template/Editing an ID Template	100
	17.2 Display Settings	101
	17.3 Coding & Linework	103
	17.4 Quality Control Settings	105
	17.5 Logging of Raw Obs	106
	17.6 Point Occupation Settings	108
18	Config...\Instrument Settings...	113
	18.1 Antenna & Antenna Heights	113
	18.2 Satellite Settings	114
	18.3 Time Zone	116
	18.4 Instrument ID	117
19	Config...\General Settings...	119
	19.1 Wizard Mode	119
	19.2 Hot Keys & User Menu	120
	19.3 Units & Formats	121
	19.4 Language	124
	19.5 Display, Beeps, Text	125
	19.6 Start Up & Power Down	127

20	Config...Interfaces... - General	129
20.1	Overview	129
20.2	Real-Time	131
20.2.1	Overview	131
20.2.2	Configuration without Real-Time Interface	132
20.2.3	Configuration of a Reference Real-Time Interface	133
20.2.4	Configuration of a Rover Real-Time Interface	138
20.2.5	Configuration of SBAS	143
20.2.6	Configuration of GGA Message Sending for Reference Network Applications	144
20.3	Hidden Point	146
20.4	SmartAntenna	149
20.5	Internet	151
21	Configuration of Devices	153
21.1	Overview	153
21.2	Accessing CONFIGURE Devices / GPRS Internet Devices	154
21.3	Creating a New Device / Editing a Device	156
22	Config...Interfaces... - Controlling Devices	159
22.1	Accessing Config...Interfaces... - Controlling Devices	159
22.2	Digital Cellular Phones	160
22.3	Radios	163
22.4	Hidden Point Measurement Devices	164
22.5	GPRS / Internet Devices	165
22.6	Creating a New Station to Dial/Editing a Station to Dial	166
22.7	Creating a New Server to Connect/Editing a Server to Connect	168
23	Tools...	171
23.1	Format Memory Device	171
23.2	Transfer Objects...	172
23.3	Upload System Files...	173
23.4	Calculator and File Viewer	174
23.5	Licence Keys	175
24	STATUS	177
24.1	STATUS: Survey...	177
24.1.1	Satellite Status	177
24.1.2	Real-Time Status	179
24.1.3	Current Position	184
24.1.4	Logging Status	186
24.1.5	Occupation Information Status	189
24.2	STATUS: Battery & Memory	191
24.3	STATUS: System Information	193
24.4	STATUS: Interfaces...	194
25	NTRIP via Internet	195
25.1	Overview	195
25.2	Configuring a Real-Time Rover for Using NTRIP Service	196
25.2.1	Configuring an Access to the Internet	196
25.2.2	Configuring to Connect to a Server	198
25.2.3	Using the NTRIP Service with a Real-Time Rover	200
26	Menu Tree	203
	Index	205

1 User Interface

1.1 Keyboard

Keyboard

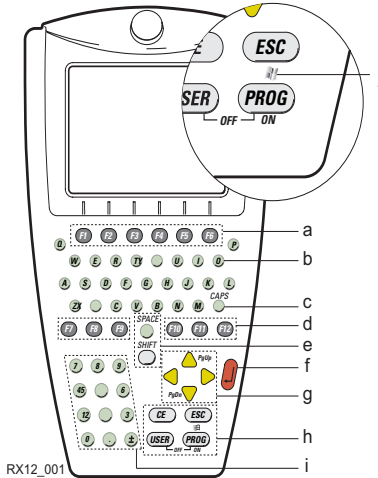

- a) Function keys **F1-F6**
- b) Alpha keys
- c) **CAPS**
- d) Hot keys **F7-F12**
- e) **SPACE, SHIFT**
- f) **ENTER**
- g) Arrow keys
- h) **CE, ESC, USER, PROG**
- i) Numeric keys
- j) For RX1250: Windows key symbol. It is the Microsoft flag logo located between **PROG** and **ESC**.





For the purpose of the illustration, a RX1250 model has been selected which is representative for all models. Differences to other RX1200 models are outlined.

Keys

Key	Function
Function keys F1-F6	Correspond to the six softkeys that appear on the bottom of the screen when the screen is activated.
Hot keys F7-F12	User definable keys to execute chosen commands or access chosen screens.
Alpha keys	To type letters.
Numeric keys	To type numbers.
CAPS	Switches between upper case to lower case letters.
CE	<ul style="list-style-type: none"> • Clears all entry at the beginning of user input. • Clears the last character during user input.
ESC	<ul style="list-style-type: none"> • Leaves the current menu or dialogue without storing any changes made. • Turns receiver off when hold for 2 s in GPS1200 Main Menu.
PROG (ON)	<ul style="list-style-type: none"> • If the sensor is off: hold for 2 s to turn the sensor on. • If the sensor is on: press at any time to access XX Programs to select an application.

Key	Function
SHIFT	Switches between the first and the second level of function keys.
SPACE	Enters a blank.
USER	Calls the user defined menu.
Arrow keys	Move the focus on the screen.
ENTER	<ul style="list-style-type: none"> • Selects the highlighted line and leads to the next logical menu / dialog. • Starts the edit mode for edit fields. • Opens a choicelist.

Key combinations

Keys	Function
PROG plus USER	<ul style="list-style-type: none"> • For RX1210/RX1250: Turns instrument off.
SHIFT  ages	up.
SHIFT  ages	down.
SHIFT PROG ()	For RX1250: Displays either the Windows CE task bar and start menu.

1.2 Screen

Screen

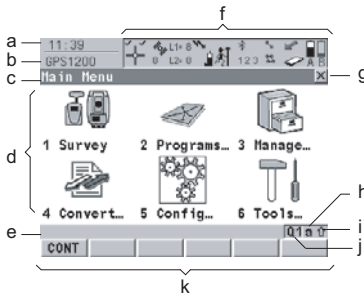

GPS12 129

- a) Time
- b) Caption
- c) Title
- d) Screen area
- e) Message line
- f) Icons
- g) ESC ☒
- h) CAPS
- i) SHIFT icon
- j) Quick coding icon
- k) Softkeys

Elements

Element	Description
Time	The current local time is shown.
Caption	Shows location either in Main Menu , under PROG key or USER key.
Title	Name of the screen is shown.
Screen area	The working area of the screen.
Message line	Messages are shown for 10 s.
Icons	Shows current status information of the instrument. Refer to "1.4 Icons". Can be used with touch screen.
ESC ☒	Can be used with touchscreen. Same functionality as the fixed key ESC . The last operation will be undone.
CAPS	The caps mode for upper case letters is active. The caps mode is activated and deactivated by pressing the CAPS key.
SHIFT icon	Shows the status of the SHIFT key; either first or second level of softkeys is selected. Can be used with touch screen and has the same functionality as the fixed key SHIFT .
Quick coding icon	Shows the quick coding configuration. Can be used with touch screen to turn quick coding on and off.
Softkeys	Commands can be executed using F1-F6 keys. The commands assigned to the softkeys are screen dependent. Can be used directly with touch screen.

1.3 Operating Principles

Keyboard and touch screen

The user interface is operated either by the keyboard or by the touch screen with supplied stylus.

The workflow is the same for keyboard and touch screen. The difference is the way information is selected and entered.

Operation by keyboard

Information is selected and entered using the keys. Refer to "1.1 Keyboard" for a detailed description of the keys on the keyboard and their function.

Operation by touch screen

Information is selected and entered on the screen using the supplied stylus.

Operation	Description
To select an item	Tap on the item.
To start the edit mode in input fields	Tap on the input field.
To highlight an item or parts of it for editing	Drag the supplied stylus from the left to the right.
To accept data entered into an input field and exit the edit mode	Tap on the screen outside of the input field.

Turn receiver on

Hold **PROG** for 2 s.

Turn receiver off

The receiver can only be turned off in **GPS1200 Main Menu**.

Press both **USER** and **PROG** simultaneously.

OR

Hold **ESC** for 2 s.

Lock/Unlock keyboard (only RX1210/RX1210T)

Option	Description
Lock	To lock the keyboard press and hold SHIFT for 3 s. The message 'Keyboard locked' is momentarily displayed on the Message Line.
Unlock	To unlock the keyboard press and hold SHIFT for 3 s. The message 'Keyboard unlocked' is momentarily displayed on the Message Line.

Selecting from a menu

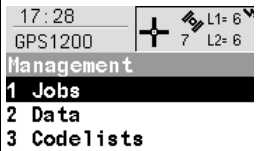
Appearance	Description
 <p>The screenshot shows a menu with the following items: '17:28', 'GPS1200', 'Management', '1 Jobs', '2 Data', and '3 Code lists'. The '1 Jobs' item is highlighted with a black background and white text. To the right of the menu is a small icon of a crosshair with 'L1= 6' and 'L2= 6' next to it.</p>	<p>To select an item from a menu, do one of the following:</p> <ul style="list-style-type: none"> Move the focus to the item. ENTER or CONT (F1). <p>OR</p> <ul style="list-style-type: none"> Type the complete selection number in front of the item. ENTER or CONT (F1) are not required.

Appearance	Description
	OR Tap on the item.

Selecting a page

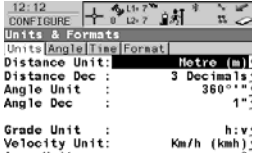
Appearance	Description
	To select a page in a screen, do one of the following: PAGE (F6). OR Tap on the page tab.

Edit an entire value in input fields

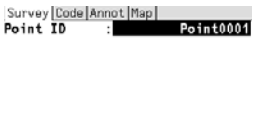
Appearance	Description
	<ol style="list-style-type: none"> 1. Highlight the field. 2. Type numeric and/or alphanumeric characters to overwrite. 3. ENTER or tap outside of the field.

Edit an individual character in input fields

Appearance	Description
	<p>A character can be inserted or overwritten. The procedure is the same for both cases.</p> <ol style="list-style-type: none"> 1. Highlight the field. 2. For the keyboard: ENTER. The edit mode is activated where additional functions like insert and overwrite are available. 3. For the touch screen: Highlight the characters to be changed. 4. Type numeric and/or alphanumeric characters. 5. ENTER or tap outside of the field.



Access special alphanumeric characters for input

Step	Description
1.	Highlight the input field.
2.	For the keyboard: ENTER .
3.	Toggle to the desired special character set by using the up/down arrow keys.
4.	Press the function key assigned to the required character group.
5.	Press the function key with the required character.
6.	Repeat step 4. and 5. for entering more special characters of the same character set.
7.	ENTER

Appearance and selection from a choicelist

Choicelists have various appearances.

Closed choicelist



Appearance	Description	Selection
	Triangles on the right indicate further available choices.	Use the arrow keys   to toggle through the list or tap the triangles on the screen.

ENTER or tap on the field to access the choicelist. Opening a choicelist reveals either a simple listbox or a comprehensive listbox dialogue.

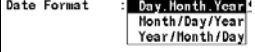
Simple listbox

Appearance	Description	Selection
	<ul style="list-style-type: none"> Choicelist shows items to select. A search field is shown if necessary. A scroll bar is shown if necessary. 	<ul style="list-style-type: none"> Highlight an item and ENTER. To exit without changes ESC or tap outside the simple listbox.

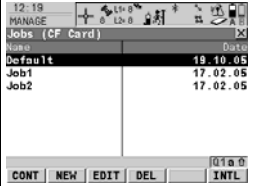
Listbox dialogue

Appearance	Description	Selection
	<ul style="list-style-type: none"> Choicelist fills the whole screen. A search field is shown. A scroll bar is shown if necessary. The functionalities comprise adding, editing and deleting of items. Listbox dialogues are explained in detail at appropriate places in the manuals. 	<ul style="list-style-type: none"> Highlight an item and CONT (F1) or ENTER. To exit without changes press ESC or tap .

1.4 Icons

Description

Icons show the current status information of the receiver.



The icons provide information related to basic receiver functions. The icons that appear depend upon which GPS1200 receiver is used and the current receiver configuration.

Position of the icons on the screen

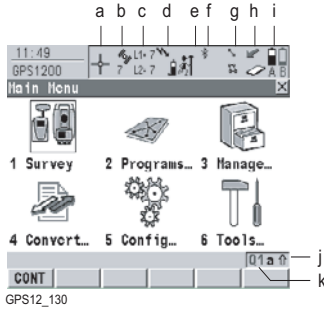

- a) Position status
- b) Number of visible satellites
- c) Contributing satellites
- d) Real-time device and real-time status, Internet online status
- e) Position mode
- f) Bluetooth
- g) Line/area
- h) CompactFlash card/internal memory
- i) Battery
- j) **SHIFT**
- k) Quick coding

Position status

Displays the status of the current position.

Touch screen: Tapping the icon leads to **STATUS Position**.

Icon	Description
No icon	No position available
	Autonomous solution available.
	Code solution available.
	Phase fixed solution available. The ticks indicate that an ambiguity check is being made.

Number of visible satellites

Displays the number of theoretically visible satellites above the configured cut off angle according to the current almanac.





Touch screen: Tapping the icon leads to **STATUS Satellites**.

Icon	Description
	The number of satellites above the <Cut Off Angle:> configured in CONFIGURE Satellite Settings .
	The number of satellites above the <Cut Off Angle:> configured in CONFIGURE Satellite Settings . Receiver is configured to accept an external oscillator input.

Contributing satellites

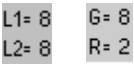
Displays the number of satellites that are contributing to the currently computed position solution.

Touch screen: Tapping the icon leads to **STATUS Satellites**.

Icon	Description
	<p>When a position status icon is displayed, the number of satellites currently used for the position computation are shown.</p> <p>If no position is currently available but satellites are being tracked then the L1 and L2 values (GPS only) or the G and R values (GPS & GLONASS) show how many satellites are being tracked.</p> <p> The number of contributing satellites can differ from the number of visible satellites. This may be either because satellites cannot be viewed or the observations to these satellites are considered to be too noisy to be used in the position solution.</p>
	<p> The number of contributing GLONASS satellites could be zero if five or more GPS satellites are used for the position computation. The processing algorithm automatically selects the best possible set of satellite combinations for the position computation. A position computation with R = 0 is certainly within the specified reliability.</p>





Real-time device and real-time status

Displays the real-time device configured to be used and its status.

Touch screen: Tapping the icon leads to **STATUS Real-Time Input**.







Real-time mode: Reference

An arrow pointing up indicates a reference configuration, it does not indicate if the device is working. The arrow flashes when a real-time message is sent. When two real-time devices are configured, then the icon for the real-time 1 device is shown.

Icon	Description
	Digital cellular phone connecting
	Digital cellular phone transmitting
	Radio transmitting
	RS232 transmitting
	Bluetooth enabled device attached and transmitting. A digital cellular phone is shown as an example.

Real-time mode: Rover

An arrow pointing down indicates a rover configuration. The arrow flashes when real-time messages are received.

Icon	Description
	Digital cellular phone connecting
	Digital cellular phone receiving
	Radio receiving
	RS232 receiving
	Bluetooth enabled device attached and receiving. A digital cellular phone is shown as an example.
	The Wide Area Augmentation System , European Geostationary Navigation Overlay Service or MTSAT Satellite-based Augmentation System is being used.





Internet online status



Icon	Description
	Receiver is online in the Internet.

Position mode

Displays the current position mode depending on the configuration defined. Symbols are added to the basic position mode icon when raw data logging or logging of auto points is configured. As soon as this icon becomes visible the receiver is in a stage where practical operation can commence.

Touch screen: Tapping the icon leads to **STATUS Logging**.





Icon	Position mode	Point occupation	Raw data logging	Logging of auto points	Move antenna
	Static	Yes	No	No	No
	Static	Yes	Yes	No	No
	Moving	No	No	No	Yes
	Moving	No	Yes	No	Yes

Icon	Position mode	Point occupation	Raw data logging	Logging of auto points	Move antenna
	Moving	No	Yes	By time	Yes
	Moving	No	Yes	By distance or height	Yes
	Moving	No	Yes	By stop & go	Yes

Bluetooth

The status of each Bluetooth port and any Bluetooth connection is displayed.

Touch screen: Tapping the icon leads to **STATUS Bluetooth**.

Icon	Description
	RX1250 or TPS instrument with Communication side cover is Bluetooth capable. In case of a RX1250, Bluetooth is integrated.
	A Bluetooth connection is established and active.
	Bluetooth connection not established. Bluetooth port 1, 2 and 3 are down. Port 2 and 3 are only available on RX1250.
	Bluetooth connection established. Bluetooth port 1, 2 and 3 are active. Port 2 and 3 are only available on RX1250.

Line/area

The number of lines and areas currently open in the active job is displayed.



Touch screen: Tapping the icon leads to **MANAGE Data: Job Name**.

Icon	Description
	The number of lines and areas which are currently open in the active job is shown.

CompactFlash card/internal memory

The status of the CompactFlash card and internal memory are displayed. For the CompactFlash card, the capacity of used space is shown in seven levels. For the internal memory, the capacity of used memory is shown in nine levels.

Touch screen: Tapping the icon leads to **STATUS Memory & Battery, Memory** page.

Icon	Description
	The CompactFlash card is inserted and can be removed.
	The CompactFlash card is inserted and cannot be removed. It is strongly recommended not to remove the CompactFlash card to avoid loss of data.

Icon	Description
	The internal memory is the active memory device.
No icon	The CompactFlash card is the active memory device. No CompactFlash card inserted.





Battery

The status and source of the battery is displayed. The remaining power in the battery is indicated by six levels.

For GPS1200 receivers: If two internal batteries are inserted, the battery with the lower voltage is used. If an external power supply is connected and one or two internal batteries are inserted, then the external power is used.

For GRX1200 Pro/GRX1200 GG Pro receivers: If two external power supplies are attached, then the system uses the one which is configured as the preferred power supply.



Touch screen: Tapping the icon leads to **STATUS Memory & Battery, Battery** page.

Icon	Description
	For GPS1200 receivers: One internal battery in battery compartment A is in use.
	For GPS1200 receivers: One internal battery in battery compartment B is in use.
	For GPS1200 receivers: Two internal batteries, one in each battery compartment A and B. Black indicates the battery currently in use.
	For GPS1200 receivers: External battery attached and in use.
	For RX1250: Internal battery is in use.

SHIFT

The status of the **SHIFT** key is displayed.

Touch screen: Tapping the icon shows additional softkeys.

Icon	Description
	Additional softkeys are available in the currently visible screen.
	The SHIFT key has been pressed.

Quick coding

The quick coding is displayed.

Touch screen: Tapping the icon turns the quick coding on or off.



Icon	Description
	Quick coding is turned on. Quick codes with one digit are used from the active codelist.

Icon	Description
Q1	Quick coding for quick codes with one digit is turned off.
Q2	Quick coding is turned on. Quick codes with two digits are used from the active codelist.
Q2	Quick coding for quick codes with two digits is turned off.
Q3	Quick coding is turned on. Quick codes with three digits are used from the active codelist.
Q3	Quick coding for quick codes with three digits is turned off.

1.5 Symbols

Description The symbols provide information regarding settings.

Filter

Symbol	Description	Example
	The filter symbol is shown on the Point, Line, Area or Map page if a point, line or area filter is active.	

Attributes

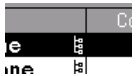
Symbol	Description	Example
	The attribute symbol is displayed in MANAGE Codes to indicate codes that have attributes attached.	

Limits

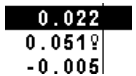
Symbol	Description	Example
	Indicates a defined limit has been exceeded. For example, the exceeding of a residual limit in the Determine Coordinate System application program.	

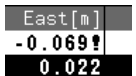

Largest residual

Symbol	Description	Example
	This symbol is used to indicate the largest residual in DET C SYS Step 4: Check Residuals .	

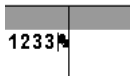
Staked out

Symbol	Description	Example
	This symbol is used in MANAGE Data: Job Name to indicate points which have been staked out.	

Wake-Up Sessions

Symbol	Description	Example
	This symbol is used in WAKE-UP Wake-Up Sessions to indicate which wake-up session is next to be activated.	

2 Equipment Setup

2.1 Receiver Ports

Description All receiver ports on the GPS1200 are located on the receiver front panel.

Ports at the receiver front panel GX1210, GX1220, GX1230, GX1230 GG, GX1200 with PPS/Event option, GRX1200 Classic and GRX1200 Lite

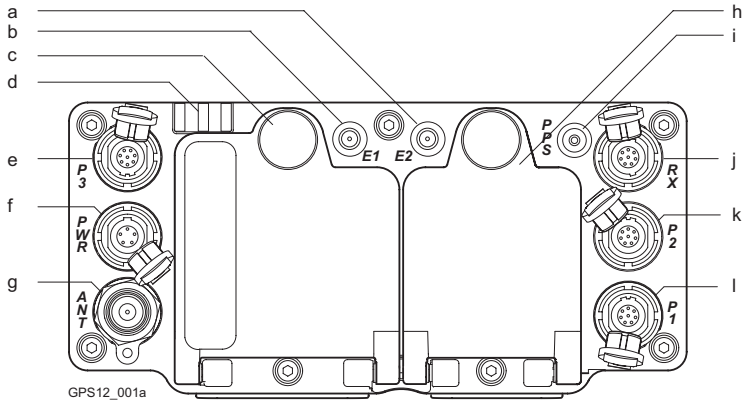

- | | |
|--|--|
| a) Port E2: Event input2, on GX1200 with PPS/Event option | g) Port ANT: GNSS antenna in. |
| b) Port E1: Event input 1, on GX1200 with PPS/Event option | h) Battery compartment B, not for GRX1200 Pro/GRX1200 GG Pro |
| c) Battery compartment A with CompactFlash card compartment | i) Port PPS: PPS output, on GX1200 with PPS/Event option |
| d) LED indicators | j) Port RX: RX1200 in/out or remote interface in/out. 8 pin LEMO |
| e) Port P3: Power out, data in/out, or remote interface in/out. 8 pin LEMO | k) Port P2: Power out, data in/out, or remote interface in/out. 8 pin LEMO |
| f) Port PWR: Power in. 5 pin LEMO | l) Port P1: Power out, data in/out, or remote interface in/out. 8 pin LEMO |

Ports to connect equipment

Equipment	Port
RX1210 without cable	Direct clip on the receiver
RX1210 using a cable	Port RX
GNSS antenna	Port ANT
Radio in a housing, without cable	Port P1 or port P3
Radio without housing, using a cable	Port P1, port P2 or port P3
Radio in a System 500 housing, using a cable	Port P1, port P2 or port P3
External power	Port PWR

2.2 Post-Processed Static Reference on Pillar

Use

The equipment setup described below is to be used for static operations on fixed surveying pillars.

Equipment setup

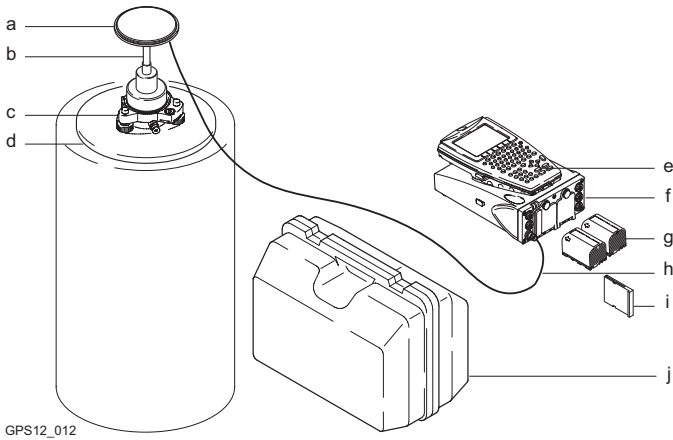

- | | |
|-----------------------------|---|
| a) GNSS antenna | f) Receiver GX1210/GX1220/
AX1201/AX1202 GG/AT504/AT504 GG |
| b) Carrier | g) Two batteries |
| c) Tribrach | h) 2.8 m antenna cable |
| d) Pillar plate if required | i) CompactFlash card |
| e) RX1210, if required | j) Transport container |

2.3 Real-Time Reference, Single Tripod

Use

The equipment setup described below is to be used for real-time reference stations with normal radio coverage. Raw observation data may also be collected for post-processing.

Equipment setup

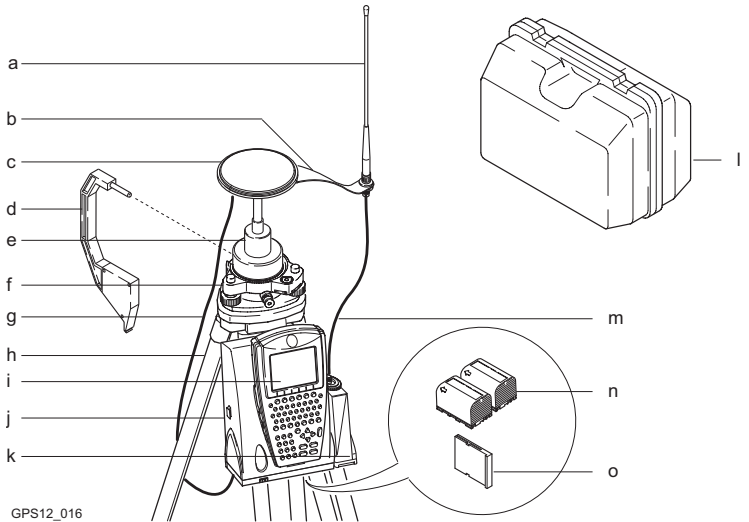

- | | |
|--|---|
| a) Radio antenna | i) RX1210, if required |
| b) Radio antenna arm 15 cm long | j) Receiver GX1210/GX1220/
GX1230/GX1230 GG |
| c) GNSS antenna AX1201/AX1202 GG | k) Radio in housing |
| d) Height hook | l) Transport container |
| e) Carrier | m) 1.2 m antenna cable to connect
radio housing to radio antenna |
| f) Tribrach | n) Two batteries |
| g) 1.2 m antenna cable to connect
receiver and GNSS antenna | o) CompactFlash card |
| h) Tripod | |

2.4 Real-Time Reference using SmartAntenna, RX1250 and GHT56

Use

The equipment setup described below is to be used for real-time reference stations using SmartAntenna (ATX1230 or ATX1230 GG), RX1250 and GHT56. This setup is intended for surveys with the need of normal radio coverage. Raw observation data may also be collected for post-processing.

Equipment setup

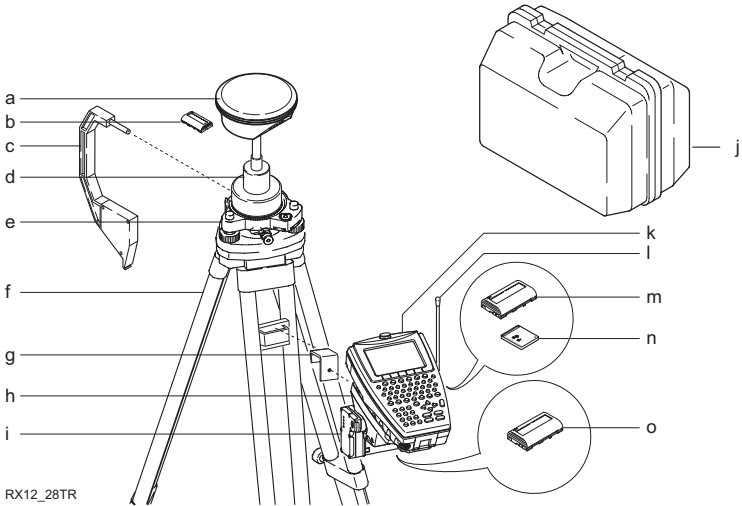

- | | |
|--|------------------------|
| a) SmartAntenna
(ATX1230 or ATX1230 GG) | i) Radio housing |
| b) Battery for SmartAntenna | j) Transport container |
| c) Height hook | k) RX1250 |
| d) Carrier | l) Radio antenna |
| e) Tribrach | m) Battery for RX1250 |
| f) Tripod | n) CompactFlash card |
| g) GHT57 | o) Battery for radio |
| h) GHT56 | |

2.5 SmartRover - External Radio

Use

The equipment setup described below is to be used for real-time rover using SmartAntenna, RX1250X, GHT56 and an external radio.

Equipment setup

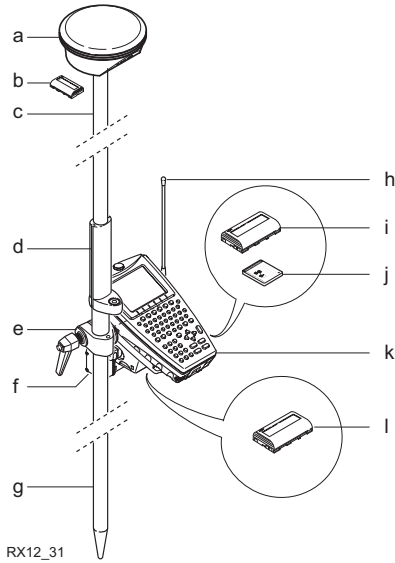

- | | |
|---|------------------------------|
| a) SmartAntenna | g) Lower half aluminium pole |
| b) Battery for SmartAntenna | h) Radio antenna |
| c) Upper half aluminium pole with screw or stub | i) Battery for RX1250X |
| d) Grip for pole | j) CompactFlash card |
| e) GHT56 | k) RX1250X |
| f) Radio in housing | l) Battery for radio |

2.6 Real-Time Rover, Pole and Minipack

Use

The equipment setup described below is to be used for a real-time rover with extended periods of use in the field. Rawobservation data may also be collected for post-processing.

Equipment setup

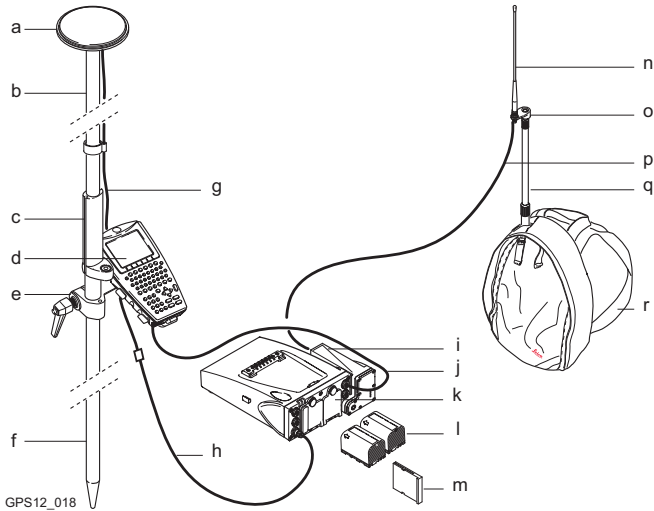

- | | |
|---|---|
| a) GNSS antenna AX1201/AX1202 GG | j) 1.8 m, RX to GX cable |
| b) Upper half aluminium pole with screw or stub | k) Receiver GX1210/GX1220/GX1230/GX1230 GG |
| c) Grip for pole | l) Two batteries |
| d) RX1210 | m) CompactFlash card |
| e) Holder for RX1210 on pole | n) Radio antenna |
| f) Lower half aluminium pole | o) Radio antenna arm 3 cm long |
| g) 1.2 m antenna cable | p) 1.2 m antenna cable to connect radio housing and radio antenna |
| h) 1.6 m antenna cable | q) Telescopic rod |
| i) Radio in housing | r) Minipack |

**Position of cables
in the minipack**

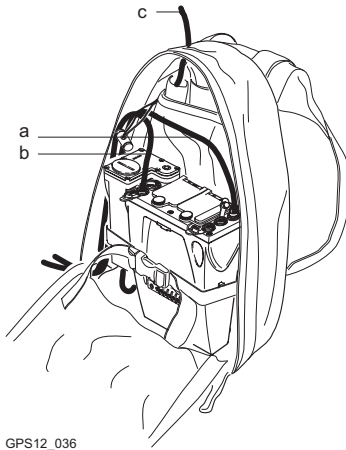

GPS12_036

- a) 1.6 m antenna cable
 - b) 1.8 m, RX to GX cable
 - c) 1.2 m antenna cable to connect radio housing and radio antenna
-

2.7 Real-Time Rover, All-on-Pole

Use

The equipment setup described below is to be used for a real-time rover with short periods of use, especially where there are many obstacles such as fences.

Equipment setup

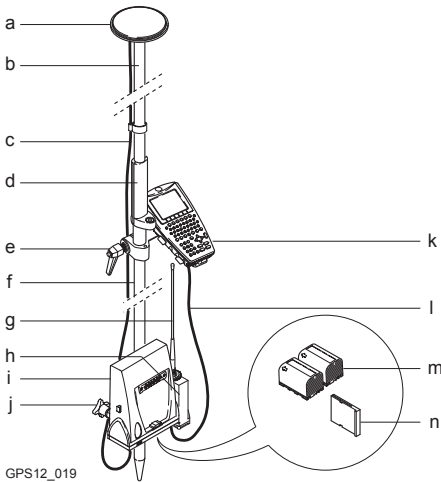

- | | |
|---|--|
| a) GNSS antenna AX1201/AX1202 GG | h) Radio in housing |
| b) Upper half aluminium pole with screw | i) Receiver GX1210/GX1220/
GX1230/GX1230 GG |
| c) 1.8 m antenna cable | j) Holder for receiver on pole |
| d) Grip for pole | k) RX1210 |
| e) Holder for RX1210 on pole | l) 1.0 m RX to GX cable |
| f) Lower half aluminium pole | m) Two batteries |
| g) Radio antenna | n) CompactFlash card |

3 Determining Antenna Heights

Pillar setup

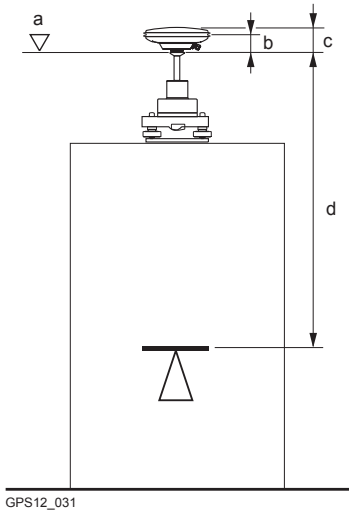

- a) Mechanical reference plane
- b) Vertical phase centre offset for L1
- c) Vertical phase centre offset for L2
- d) Vertical height reading

An AX1201/AX1202 GG antenna is shown. Vertical offset = 0

Carrier and adapter dimensions

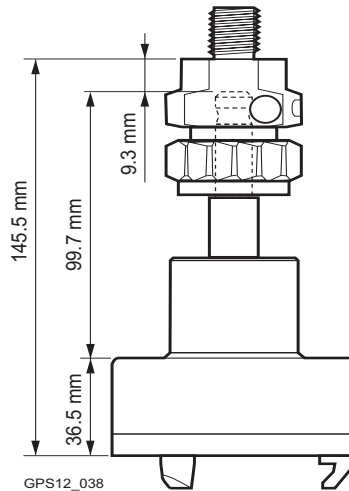

GRT144 carrier with GAD31 screw-to-stub adapter.

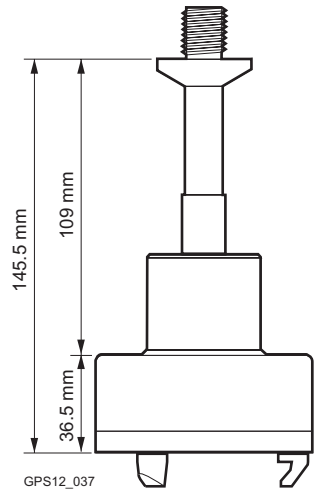

GRT146 carrier.

Tripod setup

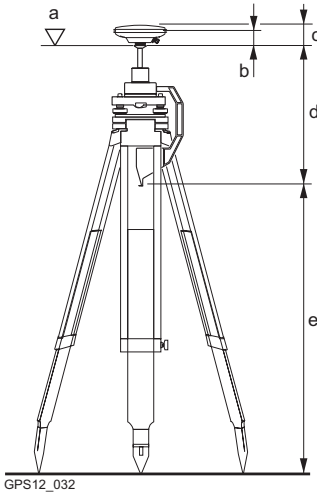

- a) Mechanical reference plane
 - b) Vertical phase centre offset for L1
 - c) Vertical phase centre offset for L2
 - d) Vertical offset
 - e) Vertical height reading
- For Leica standard antenna plus accessories: 0.36 m

An AX1201/AX1202 GG antenna is shown.

Pole setup

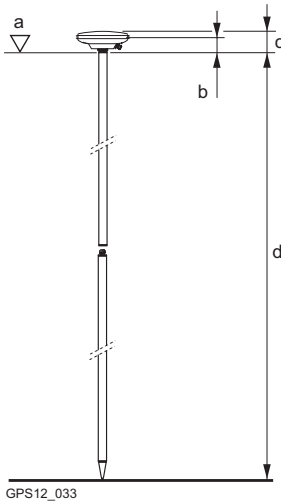

- a) Mechanical reference plane
- b) Vertical phase centre offset for L1
- c) Vertical phase centre offset for L2
- d) Vertical height reading:
 - For Leica standard pole consisting of an upper and a lower half: 2.00 m.
 - For Leica standard pole consisting of an upper and a lower half with an additional 1.00 m pole section added: 3.00 m.
 - For the lower half of the pole alone: 1.00 m.

An AX1201/AX1202 GG antenna is shown. Vertical offset = 0

4.1 Switching between Leica software and Windows CE desktop

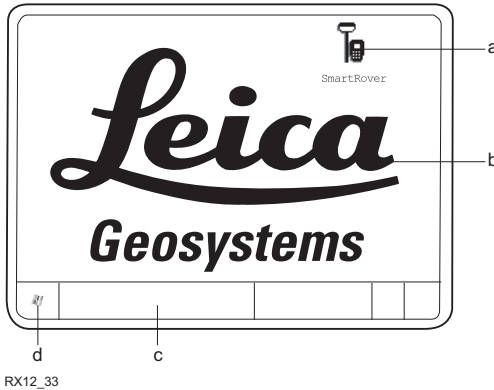

Graphic



- a) Icon to start Leica software
- b) Windows CE desktop
- c) Task bar
- d) Start button

RX12_33

Access Leica software

IF	THEN
RX1250 is started	the Leica software starts up automatically.
Windows CE desktop is active	double click  to display the Leica software. OR SHIFT PROG (#) to display the Leica software.
Leica software is minimised	double click  to maximise it. OR select SmartRover in the task bar to maximise it.

Access Windows CE desktop

IF	THEN
Leica software is to be minimised	SHIFT MINIM (F5) in Main Menu .
Leica software is to be closed	SHIFT EXIT (F6) in Main Menu .
Windows CE task bar is to be displayed	SHIFT PROG (#) .

4.2 Sleep Mode

Description

In sleep mode, the RX1250 shuts down and reduces power consumption. Rebooting RX1250 from sleep mode is quicker than a cold start after turning off.

Putting RX1250 into sleep mode

The RX1250 can only be put into sleep mode in the **Main Menu** screen.

Press **SHIFT SLEEP (F3)**.

4.3 Interface Configuration

4.3.1 Overview



Description

The required interface configurations for the RX1250 depend on the type of equipment setup.

Equipment setup	Interface configurations	Refer to chapter
Real-Time Reference using SmartAntenna, RX1250 and GHT56	• SmartAntenna interface via Bluetooth or USB	4.3.2
	• Clip-on interface for radio or digital cellular phone in clip-on-housing	4.3.3
SmartRover - External Radio	• SmartAntenna interface via Bluetooth or USB	4.3.2
	• Clip-on interface for radio or digital cellular phone in clip-on-housing	4.3.3

4.3.2 Configuring SmartAntenna Interface

Configuration step-by-step

Step	Description
1.	Select Main Menu: Config...Interfaces... in the Leica software.
2.	Highlight SmartAntenna .
3.	EDIT (F3)
4.	CONFIGURE SmartAntenna Interface <Use Device: Yes> Select a free Bluetooth port.
5.	DEVCE (F5)
6.	CONFIGURE Devices Highlight ATX1230 .
7.	CONT (F1)
8.	SRCH (F4) to search for Bluetooth devices.
	SmartAntenna must be turned on.
9.	CONFIGURE Search Bluetooth Device All available Bluetooth devices are displayed.
10.	Highlight the SmartAntenna to be used.
11.	CONT (F1)
	If the SmartAntenna selected is connected for the first time, a Windows CE authentication request comes up. Type in 0000 as identification number for Leica's Bluetooth and click OK .
	Once the Bluetooth connection is established, the Bluetooth LED on the SmartAntenna starts flashing in blue.

4.3.3 Configuring Clip-On Interface

Configuration step-
by-step

Step	Description
1.	Select Main Menu: Config...Interfaces... in the Leica software.
2.	Highlight Real-Time .
3.	EDIT (F3)
4.	CONFIGURE Real-Time Mode < R-Time Mode: Rover > or < R-Time Mode: Reference > < Port: Clip-on >
5.	DEVCE (F5) to select the device attached to the GHT56.
6.	CONT (F1) returns to CONFIGURE Interfaces .

5 Receiver Protection with PIN

Description

The receiver can be protected by a Personal Identification Number. If the PIN protection is activated, the receiver prompts for PIN code entry after starting up and before **GPS1200 Main Menu** comes up.
If a wrong PIN has been typed in five times, a **Personal UnbloCking** code is required.

This chapter explains the workflow of entering PIN and PUK.

Access

GPS1200 Enter Security PIN Code is automatically accessed during starting up the receiver when **<Use PIN: Yes>** in **CONFIGURE Start Up & Power Down, PIN Code** page and a PIN has been defined before.

GPS1200 Enter Security PUK Code is automatically accessed during starting up the receiver when a wrong PIN code has been typed in five times.

GPS1200 Enter Security PIN Code

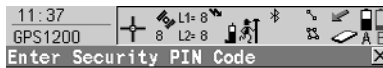

PIN Code : [REDACTED]

OK (F4)

To accept the PIN code and to continue with the subsequent screen.



SHIFT QUIT (F6)

To turn off the receiver.

Description of fields

Field	Option	Description
PIN Code	User input	The PIN code as previously defined in CONFIGURE Start Up & Power Down, PIN Code page. The correct PIN code must be typed in within five attempts or the PUK code is required.

Next step

IF the PIN code entered is	THEN
correct	GPS1200 Main Menu is displayed.
wrong	GPS1200 Enter Security PIN Code Error: 479 is displayed. OK (F4) to return to GPS1200 Enter Security PIN Code where a PIN code can be typed in again.

IF the PIN code entered is	THEN
wrong the fifth time	the PUK code is required. GPS1200 Enter Security PIN Code Error: 478 is displayed. OK (F4) to access GPS1200 Enter Security PUK Code . Refer to paragraph "GPS1200 Enter Security PUK Code".

**GPS1200
Enter Security PUK
Code**

Refer to paragraph "GPS1200 Enter Security PIN Code" for information on softkeys.

Description of fields

Field	Option	Description
PUK Code	User input	The PUK code as generated by Leica Geosystems.
		<ul style="list-style-type: none"> For receivers delivered with firmware version 2.10 or higher, the PUK code comes with the receiver.
		<ul style="list-style-type: none"> For receivers delivered with firmware versions lower than v2.10, contact a Leica representative to obtain a PUK code.
Serial No.	Output	The serial number of the receiver. This is needed to obtain the PUK code from Leica Geosystems.

Next step

IF the PUK code entered is	THEN
correct	the old PIN code is cleared and the PIN protection is deactivated. GPS1200 Main Menu is displayed.
wrong	GPS1200 keeps asking for the correct PUK code. SHIFT QUIT (F6) to turn off the receiver.

6 Manage... - Getting Started

Accessing MANAGE XX step- by-step

Step	Description
1.	Select Main Menu: Manage...
2.	GPS1200 Management Select an option in the menu.
3.	CONT (F1) to access MANAGE XX .
	MANAGE XX can directly be accessed from a choicelist in some screens for example the begin screen of application programs.

MANAGE XX

MANAGE Jobs (Device) is shown as an example. Additional softkeys are available on other screens.

The listed options are stored in the database DB-X. Any unavailable information is shown as -----.

The screen for **MANAGE Data: Job Name** consists of several pages. The objects listed and their order depend on the active sort and filter settings. An active filter for a page is indicated by Υ shown to the right of the name of the page. On the **Lines (X)** page and the **Areas (X)** page, the number in brackets next to the name of the page indicate the number of open lines/areas. Example: **Lines (2)/Areas (2)** means that two lines are open.

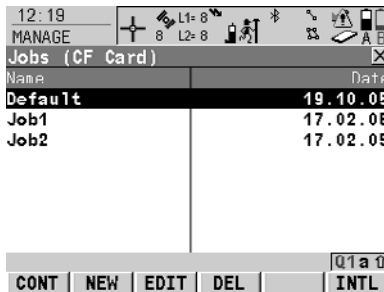

Name	Date
Default	19.10.05
Job1	17.02.05
Job2	17.02.05

CONT (F1)

To select an option and to return to the previous screen. For **MANAGE Codelists**, the codes from the highlighted codelist are copied to the active job.

NEW (F2)

To create an option. After storing a new line/area, all existing lines and areas which are open are closed.

EDIT (F3)

To edit the option. For **MANAGE Configuration Sets**, the first screen of the sequential configuration set wizard for the highlighted configuration set is accessed.

DEL (F4)

To delete the option. Available unless **MANAGE Data: Job Name, Lines (X)** page and **MANAGE Data: Job Name, Areas (X)** page.

CLOSE (F4) and OPEN (F4)

To change between the options in the **Open** column of the highlighted line/area. The options are:

Yes: The line/area is open. Measured points are assigned to the line/area.

No: The line/area is closed. Measured points are not assigned to the line/area.

MORE (F5)

To display more information in the second column. Available unless **MANAGE Jobs (Device)** and **MANAGE Antennas**.

PAGE (F6)

Available for **MANAGE Data: Job Name**. To change to another page on this screen.

CFCRD (F6) or INTL (F6)

Available for **MANAGE Jobs**. Available for receivers with internal memory. To change between viewing jobs stored on the CompactFlash card or internal memory.

SHIFT LOG (F4)

Available for **MANAGE Data: Job Name, Points** page. To view points, lines, areas and free codes stored with the job sorted by time.

SHIFT DEL (F4)

Available for **MANAGE Data: Job Name, Lines (X)** page and **MANAGE Data: Job Name, Areas (X)** page. To delete the line/area.

SHIFT SET-D (F4)

Available for **MANAGE Coordinate Systems** and **MANAGE Configuration Sets**. Available unless a default coordinate system/configuration set is highlighted. To turn the highlighted coordinate system/configuration set into a user defined default coordinate system/configuration set stored in the receiver.

SHIFT FILT (F5)

Available for **MANAGE Data: Job Name**. To define sort and filter settings.

SHIFT DEFLT (F5)

Available for **MANAGE Coordinate Systems**, **MANAGE Configuration Sets** and **MANAGE Antennas**. To recall the deleted default coordinate systems/configuration sets/antennas and to reset default configuration sets/antennas to the default settings.

Next step

IF an option	THEN
is to be selected	highlight the desired option. CONT (F1) closes the screen and returns to the screen from where MANAGE XX was accessed.
is to be created or edited	highlight the option and NEW (F2)/EDIT (F3) . Refer to the individual chapters.

7.1 Overview

Description

Jobs

- structure surveying projects.
 - contain all points, lines, areas and codes that are recorded and stored.
 - can be downloaded to LGO for post-processing or for data transfer to a further program.
 - can be uploaded from LGO, for example, for real-time stake out operations.
 - may be stored on the CompactFlash card or internal memory, if fitted.
-

7.2 Creating a New Job/Editing a Job

Access step-by-step

Step	Description
1.	Refer to "6 Manage... - Getting Started" to access MANAGE Jobs (Device) .
2.	In MANAGE Jobs (Device) highlight a job. When creating a new job, the settings of this job are applied to the new job, the codelist must be selected.
3.	NEW (F2)/EDIT (F3) to access MANAGE New Job/MANAGE Edit Job .



Editing jobs is similar to creating a new job. For simplicity, the screens are called **MANAGE XX Job** and differences are clearly outlined.

MANAGE XX Job, General page

12:21 MANAGE New Job

General Codelist Conrd. System Avge

Name : Job1

Description : -----

Creator : Ch

Device : CF Card

STORE PAGE

STORE (F1)

To store the settings and to return to **MANAGE Jobs (Device)**.

DATA (F5)

Available for editing a job. To view, edit and delete points, lines and areas stored with the job. Points, lines and areas are shown on separate pages. Selected sort and filter settings apply.

SHIFT LOG (F5)

Available for editing a job. To view, edit and delete points, lines and areas stored with the job. Points, lines and areas are sorted by time in one list.

Description of fields

Field	Option	Description
<Name:>	User input	A unique name for the new job. The name may be up to 16 characters long and may include spaces. Input required.
<Description:>	User input	Two lines for a detailed description of the job. This can be for example, work to be performed or the classes contained in the job. Input optional.
<Creator:>	User input	The person's name who is creating/editing the job. Input optional.
<Device:>	Choicelist Output	The device on which the job will be stored. For receivers with internal memory. For receivers without internal memory and when editing a job.

Next step

PAGE (F6) changes to the **Codelist** page.

MANAGE
XX Job,
Codelist page

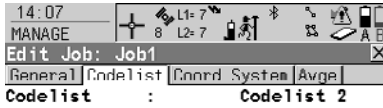

IMPRT (F2)

Available for editing a job. To add additional codes from a new codelist to the job. The name of this codelist is copied to the job.

CODES (F4)

Available for editing a job. To view, edit, delete, sort and group codes currently stored in the job. The functionality of this screen is mainly the same as for **MANAGE Codes**.

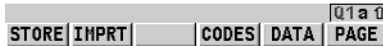

DATA (F5)

To view, edit and delete points, lines and areas stored with the job. Points, lines and areas are shown on separate pages. Selected sort and filter settings apply.

SHIFT EXPRT (F2)

Available for editing a job. To copy codes from the job to an existing or new codelist.

Description of fields

Field	Option	Description
<Codelist:>	Choicelist	Available for creating a new job or for editing a job if no codes are stored in the job. Choosing a codelist copies the codes to the job.
	Output	Available for editing a job if codes are stored in the job. If codes had been copied from a System RAM codelist, then the name of the codelist is displayed. If codes have not been copied from a System RAM codelist but typed in manually, then the name of the active job is displayed.

Next step

PAGE (F6) changes to the **Coord System** page.

MANAGE
XX Job,
Coord System
page

Choosing a coordinate system attaches it to the job. If it is not known which coordinate system to use, select **<Coord System: WGS 1984 >**.

All other fields on this screen are output fields. They depend on the transformation type of the selected coordinate system.

Next step

PAGE (F6) changes to the **Avge** page.

In order to check measurements, the same point can be measured more than once. If activated, an average or an absolute difference is calculated. Refer to paragraph "MANAGE XX Job, General page" for information on the softkeys.

Description of fields

Field	Option	Description
<Averaging Mode:>	<p>Average</p> <p>Absolute Diffs</p> <p>Off</p>	<p>Defines the averaging principles for multiple measured points.</p> <p>Computes the average for the position and the height. Points exceeding the defined limits are marked with ? in MANAGE Edit Point, Mean page.</p> <p>Computes the absolute differences between two points selected from a list of measured points which are all stored with the same point ID.</p> <p>Averaging is turned off.</p>
<Points to Use:>	Choicelist	The type of points which will be taken into account for averaging or for absolute differences.
<Avge Limit Pos:> and <Avge Limit Ht:>	User input	Available for <Averaging Mode: Average> . The acceptable difference for the position and height components.
From <Easting:> to <Cartesian Z:>	User input	Available for <Averaging Mode: Absolute Diffs> . The acceptable absolute differences for each coordinate component.

Next step

STORE (F1) stores the job and returns to **MANAGE Jobs (Device)**.

8.1 Overview

Description

Data is a generic term for points, lines and areas.

Data management is the administration of data stored in the active job. This includes

- viewing data with their related information.
 - editing data.
 - creating new data.
 - deleting existing data.
 - filtering existing data.
-

Objects

Objects

- are points, lines and areas.
 - have a unique identification ID. This is the point ID, the line ID and the area ID.
 - may or may not have a code attached. This is a point code for a point, a line code for a line and an area code for an area.
-

8.2 Point Management

8.2.1 Creating a New Point/Editing a Point

Access step-by-step

Step	Description
1.	Refer to "6 Manage... - Getting Started" to access MANAGE Data: Job Name, Points page.
2.	MANAGE Data: Job Name, Points page If a point is to be edited, then highlight the point.
3.	NEW (F2)/EDIT (F3) to access MANAGE New Point/MANAGE Edit Point: Point ID .



Editing points is similar to creating a newpoint. For simplicity, the screens are called **MANAGE XX Point** and differences are clearly outlined. If editing a point, then the visible pages and softkeys on this screen depend on the properties of thepoint being edited.

**MANAGE
XX Point,
Coords page**

13:29
MANAGE
New Point
Coords [Ende]
Point ID : 100

Easting : 764436.044 m
Northing : 253215.935 m
Ortho Ht : 428.200 m

Q1 a ↑
STORE COORD PAGE

STORE (F1)

To store the point and all associated information and to return to **MANAGE Data: Job Name, Points** page.

COORD (F2)

To view other coordinate types.

NORTH (F3) or SOUTH (F3)

Available for local geodetic or WGS 1984 geodetic coordinates when **<Local Lat:>** or **<WGS 1984 Lat:>** is highlighted. To change between North and South latitude.

EAST (F3) or WEST (F3)

Available for local geodetic or WGS 1984 geodetic coordinates when **<Local Long:>** or **<WGS 1984 Long:>** is highlighted. To change between East and West longitude.

MORE (F5)

Available for editing a point. To display information about class, sub class, 3D coordinate quality, time and date of when point was stored, instrument source and the flag for Linework if available.

SHIFT ELL H (F2) or SHIFT ORTH (F2)

Available for local coordinates. To change between the ellipsoidal and the orthometric height.

SHIFT INDIV (F5) or SHIFT RUN (F5)

To change between entering an individual point ID different to the defined ID template and the running point ID according to the ID template.

Description of fields

Field	Option	Description
<Point ID:>	User input	The name of the new point. The configured point ID template is used. The ID can be changed in the following way: <ul style="list-style-type: none">To start a new sequence of point ID's type over the point ID.For an individual point ID independent of the ID template SHIFT INDIV (F5). SHIFT RUN (F5) changes back to the next free ID from the configured ID template. If editing a point, then changing the point ID for a point of any class applies this new point ID to all other points with the same original name, regardless of class.
	Output	Points of <Class: REF> cannot be renamed.
Coordinates	User input	Negative geodetic coordinates are interpreted as being of the opposite hemisphere or other side of the meridian. For example, entering -25 °N will be stored as 25 °S, entering -33 °E will be stored as 33 °W.
	Output	If editing, then points of <Class: REF> cannot be renamed.

Next step

PAGE (F6) changes to the next page. Refer to the relevant paragraph below.

MANAGE

Edit Point: Point ID,
Obs page

For GNSS points

The name of the real-time reference station from where the GNSS point was measured, the name of antenna used to measure the point and the baseline values are shown in output fields.

For TPS points

It is possible to edit the reflector height. Changing the reflector height recalculates the point height.

The name of the station from where the point was measured is shown in an output field.

Next step

PAGE (F6) changes to the next page. Refer to the relevant paragraph below.

**MANAGE
XX Point,
Code page**

The setting for **<Themac Codes:>** in **CONFIGURE Coding & Linework** determines the availability of the subsequent fields and softkeys. For **<Themac Codes: Without Codelist>** none of the keys is available except for **STORE (F1)**.

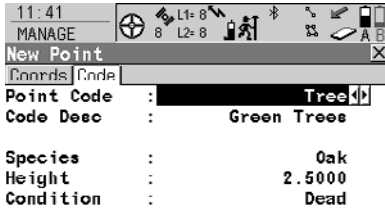

STORE (F1)

To store the point and all associated information and to return to **MANAGE Data: Job Name, Points** page.

NEW-A (F2)

To create additional attributes for the point code.

NAME (F3) or VALUE (F3)

Available for attributes for which an attribute name can be typed in. To highlight **<Attribute n:>** or the field for the attribute value. The name of **<Attribute n:>** can be edited and an attribute value can be typed in.

LAST (F4)

To recall the last used attribute values which were stored with this point code.

DEFLT (F5)

To replace all currently displayed attribute values with the default values.



Description of fields

Field	Option	Description
<Point Code:>	Choicelist	Available for <Themac Codes: With Codelist> . All point codes of the job codelist can be selected. The description of the code is shown as an output field. The attributes are shown as output, input or choicelist fields depending on their definition.
<Code:>	User input	Available for <Themac Codes: Without Codelist> . The code to be stored with the point. A check is performed to see if a point code of this name already exists in the job. If so, the according attribute values are shown.
<Attribute n:>	User input	Available for <Themac Codes: Without Codelist> . Up to eight attribute values are available.

Next step

IF	THEN
creating a point	STORE (F1) stores the point and all associated information and returns to MANAGE Data: Job Name, Points page.
editing a point	<ul style="list-style-type: none">• PAGE (F6) changes to the Annots page, if available.• PAGE (F6) changes to the Mean page, if available. Refer to "8.2.2 Mean Page" for information on softkeys and fields on the Mean page.

MANAGE

**Edit Point: Point ID,
Annots page**

The comments to be stored with the point can be edited except for <4:> if a GPS seismic value has been recorded.

Next step

STORE (F1) stores the changes and returns to **MANAGE Data: Job Name**.

8.2.2 Mean Page

Description

Various measured coordinate triplets for one point can be recorded using the same point ID. If the averaging mode is activated, an average is calculated. It is checked if the deviations of each single point are within the configured limits. After averaging, the **Mean** page becomes available in **MANAGE Edit Point: Point ID** and accessible from the Survey application program **SURVEY Survey: Job Name, Survey** page.

Averaging

Defining the averaging mode and configuring the limits

The averaging mode and the limits are configured in **MANAGE New Job, Avge** page or in **MANAGE Edit Job: Job Name, Avge** page. Refer to "7.2 Creating a New Job/Editing a Job".

Description of averaging modes

Averaging mode	Description
Average	The horizontal and height distances from the measured points to the average are computed and displayed on the Mean page.
Absolute Diffs	The same as for Average above applies for Absolute Diffs . Additionally, the absolute difference between two points selected from a list of measured points, which are all stored with the same point ID, are computed.
Off	Averaging functionality is turned off.

Access step-by-step

Access within data management

Step	Description
1.	Refer to "6 Manage... - Getting Started" to access MANAGE Data: Job Name .
2.	In MANAGE Data: Job Name, Points page highlight a point to be edited.
3.	EDIT (F3) to access MANAGE Edit Point: Point ID, Mean page.

MANAGE Edit Point: Point ID, Mean page

All measured coordinate triplets recorded using the same point ID are shown.

Use	Time	dPos	dHt	
Auto	11:48:52	0.0010	0.0068	!
Auto	11:39:05	0.0016	0.0039	!
Auto	11:38:11	0.0000	0.0000	

STORE USE EDIT DEL MORE PAGE

STORE (F1)

To store the changes and to return to the screen from where this screen was accessed.

USE (F2)

To include or exclude the highlighted coordinate triplet in or from the calculation of the average.

EDIT (F3)

To view and edit the highlighted measured coordinate triplet.

DEL (F4)

To delete the highlighted coordinate triplet. The average is recomputed.

MORE (F5)

To display more information in the second column.

SHIFT DIFFS (F5)

Available for **<Averaging Mode: Absolute Diffs>** and **Yes** set in the **Use** column for exactly two measurements. To display the absolute coordinate differences when a local coordinate system is active. Differences exceeding the defined limit are indicated by ¶.

Description of columns

Column	Description
Use	<p>The use of a measured coordinate triplet in the averaging.</p> <ul style="list-style-type: none"> • Auto The coordinate triplet is included in the averaging computation if within the defined averaging limit. • Yes The coordinate triplet is always included in the averaging computation even if it would fall outside the defined averaging limit. • No The coordinate triplet is never included in the averaging computation. • ----- The coordinate triplet cannot be included in the averaging computation. Automatically set by the system. <p>USE (F2) changes between the options.</p>
dPos	The horizontal distance from the measured coordinate triplet to the average.
dHt	The height distance from the measured coordinate triplet to the average.
¶	Available for measured coordinate triplets with Auto or Yes in the Use column if <Averaging Mode: Average> . Indicates an exceeding of the limits.

Next step

IF a measured coordinate triplet	THEN
is not to be viewed	STORE (F1) stores the changes and returns to MANAGE Data: Job Name .
is to be viewed	highlight a measured coordinate triplet and EDIT (F3) .  Codes cannot be changed. A change in codes must be an overall change for the average point.

8.3 Line/Area Management

8.3.1 Overview

Description

A line/area consists of points and can be created/edited in **MANAGE Data: Job Name**. The individual points are measured within any application program. These can be all points except auxiliary points. Points can be simultaneously assigned to one or more lines and/or areas.

A line/area can have

- a style for display in MapView.
- a code independent of the point code of the points comprising the line/area.



Points are assigned to a line/area when the line/area is open. Press **USE (F4)** to open/close a line/area.

8.3.2 Creating a New Line/Area/Editing a Line/Area



Creating/editing lines/areas and the functionality of all screens and fields are similar for lines/areas. For simplicity, only the creation/editing of a line is explained in this chapter.

Access step-by-step

Step	Description
1.	Refer to "6 Manage... - Getting Started" to access MANAGE Data: Job Name .
2.	PAGE (F6) until the Lines (X) page is active.
3.	MANAGE Data: Job Name, Lines (X) page If a line is to be edited, then highlight the line.
4.	NEW (F2)/EDIT (F3) to access MANAGE New Line/MANAGE Edit Line: Line ID .



Editing lines/areas is similar to creating a new line/area. For simplicity, the screens are called **MANAGE XX Line** and differences are clearly outlined.

MANAGE XX Line, General page

The screenshot shows the 'Edit Line: 100' screen with the following fields and values:

- Line ID: 100
- Pts to Store: All Points
- Line Style: (empty)
- No. of Pts: 0
- Length: (empty)
- Start Date: 04.11.03

Buttons at the bottom include STORE, MORE, and PAGE.

STORE (F1)

To store the line and all associated information and to return to **MANAGE Data: Job Name, Lines (X)** page. Any existing lines and areas which are open are closed.

MORE (F5)

Available on **MANAGE Edit Line: Line ID**. To display additional fields with more information.

SHIFT INDIV (F5) or SHIFT RUN (F5)

To change between entering an individual line ID different to the defined ID template and the running line ID according to the ID template.

Description of fields

Field	Option	Description
<Line ID:>	User input	The name of the new line.
<Pts to Store:>	All Points, Only Msd Pts, Only Auto Pts, Only Offset1 Pts or Only Offset2 Pts	The type of points which are used to form the line during a survey.

Field	Option	Description
<Line Style:>	Choicelist	Available on MANAGE New Line . This is the line style in which lines/areas are represented in MapView and LGO. For <Line Code: <None>> on the Code page a line style can be selected from a choicelist. Otherwise the line style as defined for the selected line code on the Code page is shown.
<No. of Pts:>	Output	The number of points contained within the line.
<Length:>	Output	Available on MANAGE Edit Line: Line ID . The sum of the distances between the points in the sequential order in which they are stored for the line. This can be a horizontal grid distance or a geodetic distance on the WGS 1984 ellipsoid.
<Start Time:> and <Start Date:>	Output	Available on MANAGE Edit Line: Line ID . The time/date when the line was created.
<End Time:> and <End Date:>	Output	Available on MANAGE Edit Line: Line ID after pressing MORE (F5) . The time/date when the last point was added to the line. The values do not change after deleting the last added point or after editing unless an additional point is added to the line.

Next step

IF	THEN
creating a line	PAGE (F6) changes to the Code page. Refer to paragraph "MANAGE XX Line, Code page".
editing a line	PAGE (F6) changes to the Points page. Refer to paragraph "MANAGE Edit Line: Line ID, Points page".

MANAGE Edit Line: Line ID, Points page

All points belonging to the line are listed. The point that was added last to the line is at the top of the list.

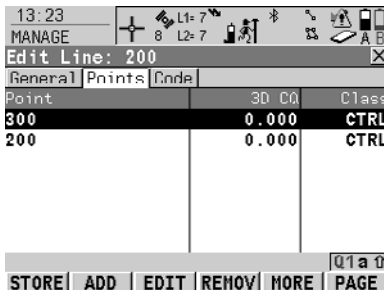

ADD (F2)

To add an existing point from the active job to the line. A new point is added before the point which was highlighted when **ADD (F2)** was pressed.

REMOV (F4)

To remove the highlighted point from the line. The point itself is not deleted.

MORE (F5)

To display more information in the second column.

Next step

PAGE (F6) changes to the **Code** page.

**MANAGE
XX Line,
Code page**

The functionality is very similar to **MANAGE New Point, Code** page. Refer to "8.2.1 Creating a New Point/Editing a Point".

Next step

STORE (F1) stores the changes and returns to **MANAGE Data: Job Name, Lines (X)** page.

**Creating
lines/areas most
efficiently**

IF the task is to create	THEN
multiple lines/areas with subsequent line/area ID's	use the hot key/user menu function FUNC Create New Line (Quick)/FUNC Create New Area (Quick) . Pressing the hot key or selecting the function from the user menu creates and immediately stores the new line/area. For the line/area ID, the line/area ID template as defined in CONFIGURE ID Templates is used. The code and attributes are taken over from the last created line/area.
lines/areas with certain codes	use quick coding. The job codelist must contain quick codes for lines/areas. By tying the quick code a new line/area is created and immediately stored with that line/area code and attributes. For the line/area ID, the line/area ID template as defined in CONFIGURE ID Templates is used.

8.4 Point Sorting and Filters

8.4.1 Sorting and Filters for Points, Lines and Areas

Description

The sort settings define the order of the objects in the active job.
The filter settings define the objects to be viewed.



An active filter for an object is indicated in **MANAGE Data: Job Name** by ∇ on the right hand side of the page name.

Access step-by-step

Step	Description
1.	Refer to "6 Manage... - Getting Started" to access MANAGE Data: Job Name .
2.	In MANAGE Data: Job Name on the Points (X) or Areas (X) page, SHIFT FILT (F5) to access MANAGE Sorts & Filters .
3.	MANAGE Sorts & Filters The page for an object is displayed when the equivalent page is displayed in MANAGE Data: Job Name .



The functionality on the **Lines (X)** and **Areas (X)** page is similar to that on the **Points** page. For simplicity, only the **Points** page is described.

MANAGE Sorts & Filters, Points page

The available fields on this screen depend on the selected setting for **<Filter:>**.

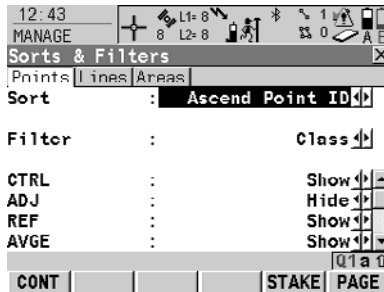

CONT (F1)

To close the screen and to return to the screen from where this screen was accessed.

STAKE (F5)

To filter points for the Stakeout application program.

Description of fields

Field	Option	Description
<Sort:>	Ascend Point ID, Descend Point ID, Forward Time or Backward Time	Always available. The method by which points are sorted.
<Filter:>	No Filter Highest Class	Always available. The method the points are filtered by. Shows all points. Shows points of highest class.

Field	Option	Description
	Range of Pt ID's	Shows points with point ID's between the entered start and end ID. The points are left aligned and sorted by the first digit.
	Pt ID Wildcard	Shows points with point ID's matching the wildcard. * and ? are supported. * indicates an undefined number of unknown characters. ? indicates a single unknown character.
	Time	Shows points which were recorded within a defined time window.
	Class	Shows points of the selected class.
	Instrument	Shows points originating from the selected instrument or software program type.
	Coordinate Type	Shows points of the selected type of coordinates.
	Point Code	Shows points with selected codes attached.
	Radius From Pt	Shows points within the defined radius from a particular point. The radius is the horizontal distance.
	Individual Line	Shows points forming a selected line. This may for example be useful during stakeout.
	Individual Area	Shows points forming a selected area. This may for example be useful during stakeout.

Next step

CONT (F1) returns to the screen from where **MANAGE Sorts & Filters** was accessed.

8.4.2 Point, Line and Area Code Filter



For each object, a code filter exists. The point, line and area code filters are independent from each other. The functionality is identical. For simplicity, only the point code filter is explained.

Access step-by-step

Step	Description
1.	Refer to "8.4.1 Sorting and Filters for Points, Lines and Areas" to access MANAGE Sorts & Filters .
2.	MANAGE Sorts & Filters <Filter: Point Code>
3.	CODES (F4) to access MANAGE Point Code Filter .

MANAGE Point Code Filter

This screen shows the point codes from the active job and codes currently used as filter.



CONT (F1)

To close the screen and return to the screen from where this screen was accessed.

GROUP (F4)

To activate and deactivate code groups. Codes belonging to a deactivated code group are not displayed in **MANAGE Code Filter**.

USE (F5)

To activate and deactivate the filter for the highlighted code.

NONE (F6) or ALL (F6)

To deactivate or activate all point codes.

SHIFT SORT (F5)

To define the order of the codes.

9.1 Creating a New Codelist/Editing a Codelist



It is recommended to create a codelist in LGO. A codelist can be transferred from LGO to the System RAM of the receiver using the CompactFlash card.

Access step-by-step

Step	Description
1.	Refer to "6 Manage... - Getting Started" to access MANAGE Codelists .
2.	NEW (F2)/EDIT (F3) to access MANAGE New Codelist/MANAGE Edit Codelist .



Editing codelists is similar to creating a new codelist. For simplicity, the screens are called **MANAGE XX Codelist** and differences are clearly outlined.

MANAGE XX Codelist

13:36
MANAGE
New Codelist

Name : Roads

Description : ----

Creator : ----

STORE CODES Q1 a 0

STORE (F1)

To store the codelist and to return to **MANAGE Codelists**.

CODES (F4)

To access **MANAGE Codes** where codes can be created, edited or deleted and code groups can be accessed.

Description of fields





Field	Option	Description
<Name:>	User input	A unique name for the codelist. The name may be up to 16 characters long and may include spaces. Input required.
<Description:>	User input	A detailed description of the codelist. This can be for example, work to be performed. Input optional.
<Creator:>	User input	The person's name who is creating the new codelist. Input optional.

Next step

STORE (F1) stores the codelist and returns to **MANAGE Codelists**.

9.2 Creating a New Code/Editing a Code

Access step-by-step

Step	Description
1.	Refer to "6 Manage... - Getting Started" to access MANAGE Codelists .
2.	In MANAGE Codelists highlight the codelist of which codes are to be managed.
3.	EDIT (F3) to access MANAGE Edit Codelist .
4.	CODES (F4) to access MANAGE Codes .
5.	MANAGE Codes Codes from currently active code groups are shown. The  indicates codes which have attributes attached.
	MORE (F5) displays information about the code description, the quick codes if available, the code groups and the code type.
	SHIFT GROUP (F4) to view, create, delete, activate and deactivate code groups.
	SHIFT SORT (F5) sorts codes by code name, code description, quick code or the last use.
6.	MANAGE Codes If a code is to be edited, then highlight the code.
7.	NEW (F2)/EDIT (F3) to access MANAGE New Code/MANAGE Edit Code .



Editing codes is similar to creating a newcode. For simplicity, the screens are called **MANAGE XX Code** and differences are clearly outlined.

**MANAGE
XX Code**

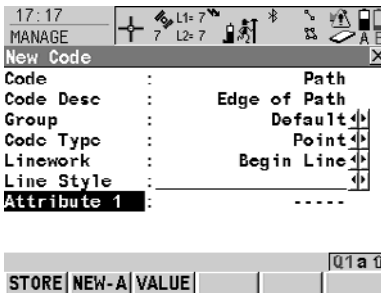

STORE (F1)

To add the new code and any associated attributes to the System RAM/job codelist and to return to the screen from where this screen was accessed.

NEW-A (F2)

To add a new input field for an attribute of attribute type normal and of value type text. Attributes of attribute type mandatory or fixed and of value type real or integer must be created in LGO. Up to twenty attributes can be created.

NAME (F3) or VALUE (F3)

Available for attributes for which an attribute name can be typed in. To highlight the field for the attribute name or the field for the attribute value. The attribute name can be edited and the attribute value to be used as the default attribute value can be typed in.

Description of fields

Field	Option	Description
<Code:>	User input	A unique name for the new code. The name may be up to 16 characters long and may include spaces. Input required.
<Code Desc:>	User input	A detailed description of the code. This can be for example the full designation if <Code:> is an abbreviation. Input optional.
<Group:>	Choicelist	The code group to which the code is to be assigned.
<Code Type:>	Choicelist	Defines the use of the code. It can be used as thematic code for points, lines or areas or as a free code. It makes a code unique. For example <Code: Oak> can have <Code Type: Point>, <Code Type: Line>, <Code Type: Area> and/or <Code Type: Free> within the same codelist and job.
<Linework:>	Choicelist	Available for <Code Type: Point> only. This field allows a new line or newarea to be opened whenever the point code is newly selected. This functionality is also available when creating codelists with LGO Codelist Management.
	None	Select this option to disable the functionality. All other code settings on the instrument are not affected when this option is set.
	Begin Line	When a point code is newly selected, a new line is opened and the point being stored is added to the line. When the same point code remains selected, a new line is not opened. The point being stored is simply added to the current line.
	Begin Area	The behaviour for opening a new area is the same as the behaviour for opening a new line, as mentioned above.
<Line Style:>	Choicelist	Not available for <Code Type: Free>. The style in which lines/areas using this case are represented in MapView and LGO.

Next step

STORE (F1) adds the code to the codelist/stores the changes and returns to **MANAGE Codelists**.

10.1 Performing Linework



The Survey application program is used here to explain Linework.

Requirements

- A display mask with a choicelist for Linework must be configured.
- The flags for Linework must be defined in **CONFIGURE Coding & Linework Settings, Linework** page.
- **<R-Time Mode: None>** or **<R-Time Mode: Rover>** in **CONFIGURE Real-Time Mode**.

Access step-by-step

Step	Description
1.	Select Main Menu: Survey to access SURVEY Survey Begin .
2.	In SURVEY Survey Begin select a job.
3.	Select a configuration set with <R-Time Mode: None> or <R-Time Mode: Rover> .
4.	Select an antenna.
5.	CONT (F1) to access SURVEY Survey: Job Name .

SURVEY

Survey: Job Name,
Survey page

The most important keys are explained.

17:24
SURVEY
Survey: Local Job
Survey [End] [Annot] [Map]
Point ID : 0001
Linework : ----
Antenna Ht : 2.000 m
3D CQ : 0.009 m
OCUPY NEAR H PNT PAGE

OCUPY (F1)

To start recording positions. The position mode icon changes to the static icon. **(F1)** changes to **STOP**.

STOP (F1)

To end recording of positions when enough data is collected. **(F1)** changes to **STORE**.

STORE (F1)

To store the point information. **(F1)** changes to **OCUPY**.

Description of fields

Field	Option	Description
<Point ID:>	User input	The identifier for manually occupied points. The configured point ID template is used. The ID can be changed in the following ways: <ul style="list-style-type: none"> • To start a new sequence of point ID's type over the point ID.

Field	Option	Description
		<ul style="list-style-type: none"> For an individual point ID independent of the ID template SHIFT INDIV (F5). SHIFT RUN (F5) changes back to the next ID from the configured ID template.
<Linework:>	<p>-----</p> <p>Begin Line</p> <p>3pt Curve</p> <p>ReOpen Any Line</p> <p>ReOpen Last Line</p> <p>End Line</p> <p>Cont Line/Area</p> <p>Start Spline</p> <p>End Spline</p> <p>Cont Spline</p> <p>Begin Area</p>	<p>The linework flag to be stored with the point.</p> <p>No linework flag is stored.</p> <p>Opens a new line when the next point is stored. Any line/area which is currently open is closed and the last point belonging to that line/area is given the End Line/Close Area linework flag. The point may or may not be stored with a point code.</p> <p>Stores the linework flag for a curve through three points and continues a line/area.</p> <p>Opens a line from a list of all lines which are currently stored in the job when the next point is stored. The last code used with the reopened line is automatically selected when the point is stored. Any line/area which is currently open is closed and the last point belonging to that line/area is given the End Line/Close Area linework flag.</p> <p>Opens the last used line again. The last code used with the reopened line is automatically selected when the point is stored.</p> <p>Closes all open lines.</p> <p>Indicates a line/area is open.</p> <p>Stores the linework flag for beginning a spline and continues any open line/area.</p> <p>Closes a spline and continues any open line/area.</p> <p>Indicates a line/area is open with spline line type.</p> <p>Opens a new area when the next point is stored. Any line/area which is currently open is closed and the last point belonging to that line/area is given the End Line/Close Area linework flag. The point may or may not be stored with a point code.</p>

Field	Option	Description
	ReOpen Any Area	Opens an area from a list of all lines which are currently stored in the job when the next point is stored. The last code used with the reopened area is automatically selected when the point is stored. Any line/area which is currently open is closed and the last point belonging to that line/area is given the End Line/Close Area line-work flag.
	ReOpen Last Area	Opens the last used area again. The last code used with the reopened area is automatically selected when the point is stored.
	Close Area	Closes all open areas.

Next step

Step	Description
1.	Go to the point to be occupied.
2.	Select the linework flag to be stored with the next point.
3.	OCUPY (F1)
4.	STOP (F1)
5.	STORE (F1)
	Depending on the option selected for <Linework:> , a line/area is opened, closed or re-opened.
6.	Repeat steps 1. to 5. until all points are occupied.
7.	SHIFT QUIT (F6) to exit the Survey application program.
8.	Use a format file to export the points including the linework flags.

10.2 Combining Linework and Coding

Description

Combining Linework and coding can only be configured if thematic point codes or if thematic point, line and area codes are available for selection. Thematic coding can be done with or without codelists.

Requirements

- A display mask must be configured with
 - a field for codes.
 - a choicelist for Linework.
- The configuration of a field for code types in a display mask is required for working with point, line and area codes without choicelist. Else the configuration of a field for code types is optional.
- Configure in **CONFIGURE Coding & Linework, Coding** page
 - **<Show Codes: Only Pt Codes>** or **<Show Codes: All Codes>**.
 - **<Themac Codes: With Codelist>** or **<Themac Codes: Without Codelist>**.
- In **CONFIGURE Coding & Linework Settings, Linework** page define the flags for Linework.
- **<R-Time Mode: None>** or **<R-Time Mode: Rover>** in **CONFIGURE Real-Time Mode**.



The Survey application program is used here to explain the combination of Linework and coding.

Access step-by-step

Step	Description
1.	Select Main Menu: Survey to access SURVEY Survey Begin .
2.	In SURVEY Survey Begin select a job.
3.	Select a configuration set with <R-Time Mode: None> or <R-Time Mode: Rover> .
4.	Select an antenna.
5.	CONT (F1) to access SURVEY Survey: Job Name .

SURVEY

**Survey: Job Name,
Survey page**

This is what a display mask configured for Linework and coding looks like. The most important keys are explained.

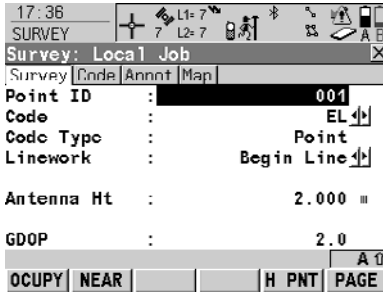

OCUPY (F1)

To start recording positions. (F1) changes to **STOP**.

STOP (F1)

To end recording of positions when enough data is collected. (F1) changes to **STORE**.



STORE (F1)

To store the point information. (F1) changes to **OCUPY**.



Linework and coding step-by-step

These step-by-step instructions refer to the previous screen.

For <Show Codes: Only Pt Codes>

Step	Field	Description for thematical coding	
		With codelist	Without codelist
1.	<Code:>	Select a code from the choicelist. Only point codes are available for selection.	Type in a code.
		<None> to store a point without code or to perform Linework without coding.	---- to store a point without code or to perform Linework without coding.
2.	<Code Type:>	Point is displayed. This field is an output field. It can not be changed.	
3.	<Linework:>	Select an option for the Linework flag to be stored with the point.	---- to store a point without Linework flag or to perform coding without Linework.
			
4.	-	OCUPY (F1)	
5.	-	STOP (F1)	
6.	-	STORE (F1)	
	-	<ul style="list-style-type: none"> The point is stored with the selected code. Depending on the selection for <Linework:>, a line/area is opened/closed. 	

For <Show Codes: All Codes>

Step	Field	Description for thematic coding	
		With codelist	Without codelist
1. 	<Code:>	Select a code from the choicelist. Point, line and area codes are available for selection. <None> to store a point without code or to perform Linework without coding.	Type in a code. ----- to store a point without code or to perform Linework without coding.
2.	<Code Type:>	The type of the selected code. This field is an output field. It can not be changed.	Select the type of the entered code.
3. 	<Linework:>	Select an option for the Linework flag to be stored with the point. ----- to store a point without Linework.	
4.	-	OCUPY (F1)	
5.	-	STOP (F1)	
6. 	-	STORE (F1)	
	-	<ul style="list-style-type: none"> If a point codewas selected, the point is stored with the selected code. If a line/area code was selected, the point is stored as part of the line/area. Depending on the selection for <Linework:>, a line/area is opened/closed. 	

11.1 Overview

Description

A coordinate system

- consists of up to five elements.
 - allows the conversion from WGS 1984 geodetic or cartesian coordinates to local cartesian, geodetic or grid coordinates and back.
-

Elements of coordinate system

The five elements which define a coordinate system are:

- a transformation
 - a projection
 - an ellipsoid
 - a geoid model
 - a **C**ountry **S**pecific **C**oordinate **S**ystem model
-

11.2 Creating a New Coordinate System/Editing a Coordinate System

Access step-by-step

Step	Description
1.	Refer to "6 Manage... - Getting Started" to access MANAGE Coordinate Systems .
2.	In MANAGE Coordinate Systems highlight a coordinate system. When creating a new coordinate system, a copy of this coordinate system is taken for further configurations.
3.	NEW (F2)/EDIT (F3) to access MANAGE New Coordinate System/MANAGE Edit Coordinate System .



Editing a coordinate system is similar to creating a new coordinate system. For simplicity, the screens are called **MANAGE XX Coordinate System** and differences are clearly outlined.

MANAGE XX Coordinate System

When editing a coordinate system the transformation type of the selected coordinate system determines the availability and the options of the subsequent fields. Most fields are identical with those for the creation of a new coordinate system.

Description of fields

Field	Option	Description
<Name:>	User input	A unique name for the coordinate system. The name may be up to 16 characters long and may include spaces.
<Residuals:>	<p>None</p> <p>1/Distance^{XX}</p> <p>Multiquadratic</p>	<p>Available for transformations with control points. The method by which residuals are distributed throughout the transformation area.</p> <p>No distribution is made. Residuals remain with their associated points.</p> <p>Distributes the residuals according to the distance between each control point and the newly transformed point.</p> <p>Distributes the residuals using a multiquadratic interpolation approach.</p>
<Transform:>	Choicelist	The type of transformation.
<Pre Transform:>	Output	Available for editing Twostep transformations. The name of a preliminary 3D transformation which is used together with the selected projection to obtain preliminary grid coordinates to be used for a final 2D transformation.
<Ellipsoid:>	Choicelist	Available unless projection <Type: Customised>. The local coordinates are based on this ellipsoid.
<Projection:>	Choicelist	The map projection.

Field	Option	Description
<Geoid Model:>	Choicelist	The geoid model.
<CSCS Model:>	Choicelist	The Country Specific Coordinate System model.



Next step

STORE (F1) stores the coordinate system and returns to **MANAGE Coordinate Systems**.

11.3 Transformations/Ellipsoids/Projections

11.3.1 Accessing Transformation/Ellipsoid/Projection Management

Access step-by-step

Step	Description
1.	Refer to "6 Manage... - Getting Started" to access MANAGE Coordinate Systems .
2.	In MANAGE Coordinate Systems highlight a coordinate system to be edited.
3.	EDIT (F3)
4.	In MANAGE Edit Coordinate System highlight <Transform:>, <Ellipsoid:> or <Projection:>.
5.	ENTER to access MANAGE XX .
	The screen is similar to MANAGE Coordinate Systems . Refer to "6 Manage... - Getting Started" for information on the softkeys.
	In MANAGE Transformations all Classic 3D transformations stored in the database DB-X are listed.

Next step

IF	THEN
a transformation/ellipsoid/projection is to be selected	highlight the desired transformation/ellipsoid/projection. CONT (F1) closes the screen and returns to the screen from where MANAGE XX was accessed.
a transformation/an ellipsoid/projection is to be created or edited	highlight the transformation/ellipsoid/projection and NEW (F2)/EDIT (F3) . Refer to "11.3.2 Creating/Editing a Transformation/Ellipsoid/Projection".

11.3.2 Creating/Editing a Transformation/Ellipsoid/Projection



Creating/editing an ellipsoid/projection is very similar to creating/editing a transformation which is explained below. The main difference is that **MANAGE XX Ellipsoid** and **MANAGE XX Projection** do not use pages and all the information is input on one screen.



Classic 3D transformations can be created.

Access step-by-step

Step	Description
1.	Refer to "11.3.1 Accessing Transformation/Ellipsoid/Projection Management" to access MANAGE Transformations .
2.	In MANAGE Transformations highlight a transformation. When creating a new transformation/ellipsoid/projection, a copy of this transformation/ellipsoid/projection is taken for further configurations.
3.	NEW (F2)/EDIT (F3) to access MANAGE New Transformation/MANAGE Edit Transformation .



Editing a transformation is similar to creating a new transformation. For simplicity, the screens are called **MANAGE XX Transformation** and differences are clearly outlined.

MANAGE XX Transformation, General page

Description of fields

Field	Option	Description
<Name:>	User input	A unique name for the transformation. The name may be up to 16 characters long and may include spaces.
<Type:>	Output	No other transformations than Classic 3D can be created.

Next step

PAGE (F6) changes to the **Parameters** page.

MANAGE XX Transformation, Parameters page

Next step

PAGE (F6) changes to the **More** page.

MANAGE XX Transformation, More page

Description of fields

Field	Option	Description
<Height Mode:>	Choicelist or Output	The type of heights to be computed. When editing a transformation, the option cannot be changed.

Field	Option	Description
<Transf Model:>	Choicelist	The transformation model to be used. For <Transf Model: Molodensky-Bad>, additional input fields are available.

Next step

STORE (F1) stores the transformation and returns to **MANAGE Transformations**.

11.4 Geoid/CSCS Models



The creation of CSCS models on the receiver and the functionality of all screens and fields is similar to those for geoid models. For simplicity, geoid models are used as an example in this chapter.

Access step-by-step

Step	Description
1.	Refer to "6 Manage... - Getting Started" to access MANAGE Coordinate Systems .
2.	In MANAGE Coordinate Systems highlight a coordinate system to be edited.
3.	EDIT (F3) to access MANAGE Edit Coordinate System .
4.	In MANAGE Edit Coordinate System highlight <Geoid Model:> .
5.	ENTER to access MANAGE Geoid Models .

MANAGE Geoid Models

All geoid models stored in the database DB-X are listed. Any unavailable information is shown as -----, for example, if the geoid field file which was associated to the geoid model is not available on the CompactFlash card / internal memory.

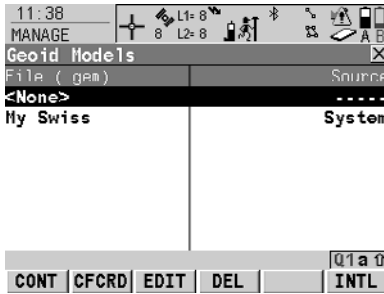

CONT (F1)

To select the highlighted geoid model and to return to the previous screen.

CFCRD (F2)

To create a new geoid model. For each geoid field file on the CompactFlash card, one geoid model is automatically created.

EDIT (F3)

To view the highlighted geoid model. None of the fields can be edited.

DEL (F4)

To delete the highlighted geoid model. The geoid field file which was associated with this geoid model is then also deleted.

INTL (F6)

To create a new geoid model. For each geoid field file in the internal memory, one geoid model is automatically created.

12 Manage... \Configuration Sets

12.1 Overview

Description	The receiver has numerous user configurable parameters and functions. This allows a variety of preferences to be addressed. The configuration of the parameters and functions for an individual measuring technique are combined in a configuration set.
Default configuration sets	Default configuration sets exist on the instrument. They use standard settings for the majority of application programs. Default configuration sets can be edited and deleted. It is always possible to restore the default configuration sets.
User defined configuration sets	New configuration sets can be created. The configuration set wizard assists in editing configuration sets.

12.2 Creating a New Configuration Set

Access step-by-step

Step	Description
1.	Refer to "6 Manage... - Getting Started" to access MANAGE Configuration Sets .
2.	In MANAGE Configuration Sets highlight a configuration set. A copy of this configuration set is taken for further configurations.
3.	NEW (F2) to access MANAGE New Configuration Set .

MANAGE New Configuration Set

Description of fields

Field	Option	Description
<Name:>	User input	A unique name for the new configuration set.
<Description:>	User input	A detailed description of the configuration set, since the name of a configuration set is usually an abbreviation. Input optional.
<Creator:>	User input	The person's name who creates the new configuration set. Input optional.

Next step

STORE (F1) accesses the next subsequent screen in the configuration wizard. Refer to the chapters "Config...\XX" for information on the screens.

12.3 Editing a Configuration Set

Access step-by-step with using configuration set wizard

Step	Description
1.	Refer to "6 Manage... - Getting Started" to access MANAGE Configuration Sets .
2.	In MANAGE Configuration Sets highlight a configuration set to be edited.
3.	EDIT (F3) to access CONFIGURE Wizard Mode . This starts the sequential configuration set wizard.
4.	Refer to the chapters "Config...\XX" for information on the screens.

Access without using the configuration set wizard

The currently active configuration set can be edited. Choose one of the following options and access the required screens to edit the configuration set.

Select **Main Menu: Config...**

OR

From inside an application program press **USER** and then **CONF (F2)**.

OR

In **CONFIGURE Wizard Mode**, press **LIST (F6)**.

13.1 Overview

Description

- Leica Geosystems antennas are predefined as default and can be selected from a list.
 - Additional antennas can be defined.
 - Default antennas contain an elevation dependent correction model.
 - New antenna correction models can be set up and transferred to the receiver using LGO.
-

13.2 Creating a New Antenna/Editing an Antenna

Access step-by-step

Step	Description
1.	Refer to "6 Manage... - Getting Started" to access MANAGE Antennas .
2.	In MANAGE Antennas highlight an antenna. When creating a new antenna, highlight the antenna with offset characteristics similar to those required by the new antenna.
3.	NEW (F2)/EDIT (F3) to access MANAGE New Antenna/MANAGE Edit Antenna .



Editing antennas is similar to creating a new antenna. All fields can be edited except those of Leica default antennas. For simplicity, the screens are called **MANAGE XX Antenna**.

MANAGE XX Antenna, General page

13:20
MANAGE
New Antenna
General TBS
Name : New Antenna
Hz Offset : 0.0000
V Offset : 0.3600
L1 PhOffset : 0.0648
L2 PhOffset : 0.0622
Copy Additional Corrections : Yes
STORE PAGE

STORE (F1)

To store the new antenna and to return to **MANAGE Antennas**.

Description of fields

Field	Option	Description
<Name:>	User input	A unique name for the new antenna.
<Hz Offset:>	User input	Horizontal offset of measurement reference point.
<V Offset:>	User input	Vertical offset of measurement reference point.
<L1 PhOffset:>	User input	Offset of L1 phase centre.
<L2 PhOffset:>	User input	Offset of L2 phase centre.
<Copy Additional Corrections:>	Yes or No	Allows additional corrections to be copied from the antenna which was highlighted when MANAGE New Antenna was accessed.

Next step

PAGE (F6) changes to the **IGS** page.

**MANAGE
New Antenna,
IGS page**

The combination of values typed in on this page provides a unique standardised ID for the antenna being used.

Description of fields

Field	Option	Description
<IGS Name:>	User input	The International GPS Service name of the antenna.
<Serial Number:>	User input	The serial number of the antenna.
<Set Up Number:>	User input	The set up number of the antenna. This identifies the version number of the current calibration.

Next step

STORE (F1) stores the antenna and returns to **MANAGE Antennas**.

14 Convert...\Export Data from Job

14.1 Overview

Description

The settings on this screen define the data that is converted and exported and what format is used.

Data is exported from the selected job. Currently active view, filter and sort settings are applied. The points that are exported are those that are visible in **MANAGE Data: Job Name**.

Data can be exported

- to a file on the CompactFlash card.
 - to a file on the internal memory, if fitted.
 - via RS232 to a Leica TPS400/700 instrument.
-

Export format

The export format must be composed individually as format file using LGO. Refer to the online help of LGO for information on creating format files.

14.2 Exporting ASCII Data

Requirements

At least one format file was created using LGO and has been transferred to the System RAM.

Access

Select **Main Menu: Convert...\Export Data from Job.**

EXPORT Export ASCII Data from Job

17:16 EXPORT

Export ASCII Data from Job

Export To : CF Card

Directory : Data

Job : Default

Coord System : WGS84

Format File : gsi16.FRT

File Name : Default.txt

CONT CONF FILT CSYS

CONT (F1)

To export the data.

CONF (F2)

To define the default extension for the export file and to select the behaviour for the Setup measurements.

FILT (F4)

To set the sort and filter settings for export. The setting for **<Sort:>** on the **Points** page defines the order in which points, lines and areas are exported. The setting for **<Filter:>** on each page defines which points, lines or areas are exported.

IFACE (F5)

Available for **<Export To: RS232>**. To choose the port and device to which the data should be exported.

CSYS (F6)

To update the coordinate system in which the coordinates are exported.

Description of fields

Field	Option	Description
<Export To:>	CF Card, Internal Memory , if fitted, or RS232	Defines to where the exported file should be written.
<Directory:>	Data, GSI or /Root	Available for <Export To: CF Card> . The data can be exported to the \Data , the \GIS or the oot directory. Data must be stored to the \GSI directory in order to read it in a TPS1100. For <Export To: Internal Memory> , the data is always exported to the \Data directory.

Field	Option	Description
<Job:>	Choicelist	If points from a job on the internal memory are to be exported, open this choicelist. When in this choicelist press CFCRD (F6) or INTL (F6) to select a job from a different memory device.
<Coord System:>	Output	The coordinate system currently attached to the selected <Job:>.
<Format File:>	Choicelist	The format files currently available in the System RAM.
<File Name:>	User input	Available for <Export To: CF Card> and <Export To: Internal Memory>. The name of the file to which the data should be exported. The name is automatically suggested based on the job name to be exported and an extension.
<Port:>	Output	Available for <Export To: RS232>. Displays the port currently configured to be used with RS232.
<Device:>	Output	The device currently configured to be used with <Port:>.

15 Convert...\Import Data to Job

15.1 Overview

Description

This screen lists all the importers loaded. The data to import must be stored on the CompactFlash card.

Data can be imported to a job

- on the CompactFlash card.
- on the internal memory, if fitted.

Import formats

Data can be imported in ASCII, GSI8, GSI16 or DXF format.

Access step-by-step

Step	Description
1.	Select Main Menu: Convert...\Import Data to Job to access IMPORT Import Data to Job Menu .
2.	IMPORT Import Data to Job Menu The Import Data to Job menu lists all the converters for importing data. Highlight the Import Data converter to be started.
3.	CONT (F1) to access the screen for the Import Data converter.
	The screens for each Import Data converter can be accessed directly by pressing a configured hot key or USER .

15.2 Importing ASCII/GSI Data

Requirements

- For ASCII files:
At least one ASCII file with any file extension is stored in the \DATA directory of the CompactFlash card.
- For GSI files:
At least one ASCII file in GSI format with the file extension *.gsi is stored in the \GSI directory of the CompactFlash card.

Access

Refer to "15.1 Overview" to access **Import ASCII/GSI Data to Job**.

IMPORT Import ASCII/GSI Data to Job

17:23
IMPORT
Import ASCII/GSI Data to Job

From : CF Card
Import : ASCII Data
From File : logfile.txt
To Job : Job1
Header : None

CONT CONF VIEW

CONT (F1)

To import the data.

CONF (F2)

For **<Import: ASCII Data>**: To select the delimiter, the positions of the particular variables and, if required, the number of lines used to describe each point or if the variables are delimited by one or multi spaces.

For **<Import: GSI Data>**: Coordinates can be switched for "left handed" coordinate systems. All WI 81 data, normally Easting, is then imported as Northing and all WI 82 data, normally Northing, is then imported as Easting.

VIEW (F3)

To display the data in **<From File>**.

SHIFT HTS (F2)

To define the height type for the imported data and if the Easting should be multiplied by -1. This is required by some coordinate systems.

Description of fields

Field	Option	Description
<From:>	Choicelist	ASCII/GSI data can be imported to a job, from either the CompactFlash card or internal memory.
<Import:>	Choicelist	The type of data to be imported.
<From File:>	Choicelist	For <Import: ASCII Data> all files in the \DATA directory on the CompactFlash card can be selected. For <Import: GSI Data> all files in the \GSI directory on the CompactFlash card can be selected.

Field	Option	Description
<To Job:>	Choicelist	Choosing a job as destination for import makes this job the active job.
<Header:>	None and from 1 to 10	Available for <Import: ASCII Data>. This option allows up to ten header lines which may exist in an ASCII file to be skipped. Select the number of header lines.

15.3 Importing DXF Data

Requirements

- At least one DXF file with the file extension *.dxf has to be stored in the \DATA directory of the CompactFlash card.

Access

Refer to "15.1 Overview" to access **Import DXF Data to Job**.

DXF IMPORT

Import DXF Data to Job

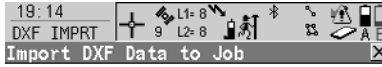

From File : Tennis Court
To Job : Job1

Progress :



Description of fields

Field	Option	Description
<From:>	Choicelist	DXF data can be imported to a job, from either the CompactFlash card or internal memory.
<To Job:>	Choicelist	Choosing a job as destination for import makes this job the active job.
<Progress:>	Output	Progress bar of the import procedure.

CONT (F1)

To import the data.

CONF (F2)

To define an optional prefix for blocks, points and/or lines, to select the file units and to activate the creation of points at vertices of the imported geometric elements, if required.

16 Convert...\Copy Points Between Jobs

Description

This chapter explains the process of copying points from one job to another.

Access

Select **Main Menu: Convert...\Copy Points Between Jobs**.

**COPY
Copy Points
Between Jobs**

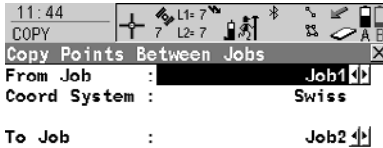

CONT (F1)

To copy a selection of points.

FILT (F4)

To define the point sort and/or point filter settings of points from the job <From Job:>.

DATA (F5)

To view, edit and delete points, lines and areas stored with the job. Points, lines and areas are shown on separate pages. Selected sort and filter settings apply.

CSYS (F6)

To select a different coordinate system.



Description of fields

Field	Option	Description
<From Job:>	Choicelist	Describes where the points are to be copied from.
<Coord System:>	Output	The coordinate system which is currently attached to the job <From Job:>.
<To Job:>	Choicelist	Describes where the points are to be copied to.

17 Config...\Survey Settings...

17.1 ID Templates

17.1.1 Overview

Description

ID templates are predefined templates for point, line or area numbers. ID templates save having to type in the ID for each object. They are useful when many points are collected quickly, for example in post-processed and real-time kinematic operations.

Access

Select **Main Menu: Config...\Survey Settings...\ID Templates.**

CONFIGURE ID Templates

Description of fields

Field	Option	Description
<Survey Pts:>	Choicelist	Sets the ID templates for manually occupied points.
<Auto Pts:>	Choicelist	Sets the ID templates for auto points. These points are automatically recorded at a specific rate.
<Auxil Pts:>	Choicelist	Sets the ID templates for auxiliary points. These points are used when trying to find a stake-out point.
<Lines:>	Choicelist	Sets the ID templates for lines.
<Areas:>	Choicelist	Sets the ID templates for areas.

Next step

CONT (F1) closes the screen and returns to the screen from where **CONFIGURE ID Templates** was accessed.

17.1.2 Creating a New ID Template/Editing an ID Template

Access step-by-step

Step	Description
1.	Refer to "17.1.1 Overview" to access CONFIGURE ID Templates .
2.	In CONFIGURE ID Templates highlight any field.
3.	ENTER to access CONFIGURE ID Template Library .
4.	Highlight an ID template. A copy of this ID template is taken for further configurations.
5.	NEW (F2)/EDIT (F3) to access CONFIGURE New ID Template/CONFIGURE Edit ID Template .
	DEL (F4) deletes the highlighted template.



Editing ID templates is similar to creating a new ID template. For simplicity, the screens are called **MANAGE XX ID Templates** and differences are clearly outlined.

**CONFIGURE
XX ID Template**

Description of fields

Field	Option	Description
<ID:>	User input	The name of the ID template.
<Increment:>	Numeric only	The rightmost numeric part is incremented within the point ID.
	Alphanumeric	The rightmost character within the point ID is incremented regardless of whether that character is numeric or alphanumeric.
<Increment By:>	User input	The amount by which the ID is incremented.
<Cursor Posn:>	Last Character or from 1 to 16	The character position at which the cursor is placed when ENTER is pressed in <Point ID:> when surveying points.

Next step

CONT (F1) stores the ID template and returns to **CONFIGURE ID Template Library**.

17.2 Display Settings

Description Display settings define the parameters shown on a page on the **SURVEY** screen.

Four display masks are definable.

- Mask 1: Always shown on the **SURVEY** screen.
- Mask 2: Can be shown or hidden on the **SURVEY** screen.
- Mask 3: Can be shown or hidden on the **SURVEY** screen.
- Mask 4: Never shown on the **SURVEY** screen. Reserved for application programs.

Access Select **Main Menu: Config...\Survey Settings...\Display Settings**.

CONFIGURE
Display Settings

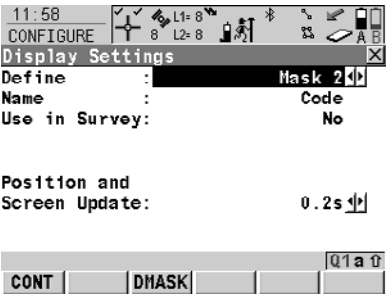

- CONT (F1)**
To accept changes and return to the screen from where this screen was accessed.
- DMASK (F3)**
To configure the selected display mask.

Description of fields

Field	Option	Description
<Define:>	Mask 1, 2, 3 or 4	Selected display mask.
<Use in Survey:>	Output	Indicates if the display mask is shown or hidden as a page in SURVEY .
<Position and Screen Update:>	From 0.05s to 1.0s	Determines how often positions are computed and the screen display is updated. The maximum update rate using Bluetooth on RX1250 is 0.2 s.

Next step
DMASK (F3) accesses **CONFIGURE Define Display Mask n**.

CONFIGURE
Define Display
Mask n

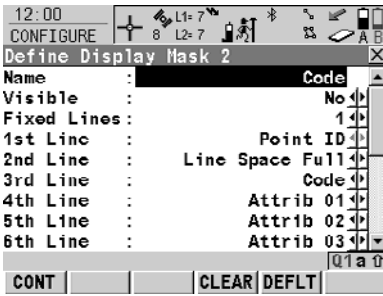

CONT (F1)

To accept changes and to return to **CONFIGURE Display Settings**.

CLEAR (F4)

To set all fields to **<XX. Line: Line Space Full>**.

DEFLT (F5)

To recall the default settings.

Description of fields

Field	Option	Description
<Visible:>	Yes or No	Shows or hides the display mask as a page in SURVEY .
<Fixed Lines:>	From 0 to 5	Defines how many lines do not scroll in the survey screen when that display mask is used.
<1st Line:>	Output	Fixed to <1st Line: Point ID> .
<2nd Line:> to <16th Line:>	Choicelist	For each line an option can be selected.

Next step

CONT (F1) returns to **CONFIGURE Display Settings**.

17.3 Coding & Linework

Description The settings on this screen define the method of coding.

Access Select **Main Menu: Config...\Survey Settings...\Coding & Linework Settings.**

**CONFIGURE
Coding & Line-
work,
Coding page**

Description of fields

Field	Option	Description
<Quick Code:>	Never, On or Off	Determines if quick coding is never available, activated or available but deactivated.
<Digits:>	1, 2 or 3 Available	unless <Quick Code: Never>. Sets the mostly used number of digits for the quick code.
<Rec Free Code:>	After Point or Before Point	Available unless <Quick Code: Never>. Determines if a free code measured witha quick code is stored before or after the point.
<Attributes:>	Default Values or Last Used	Determines the attribute values displayed under certain circumstances. This is applicable to both the storing and displaying of attribute values.
<Mand Attribs:>	Always Prompt	The screen XX Enter Mandatory Attribute will always appear when codes, having one or more attributes of attribute type mandatory, are being stored.
	Only If No Value	The screen XX Enter Mandatory Attribute will only appear when codes, having one or more attributes of attribute type mandatory, are being stored without an attribute value.
	Code Change Only	The screen XX Enter Mandatory Attribute will only appear when a new code witha mandatory attribute was selected.
<Themac Codes:>	With Codelist	Codes stored within the job codelist can be selected to code points, lines and areas.
	Without Codelist	Codes stored within the job codelist cannot be selected to code points, lines and areas. Each code must be entered manually.
<Show Codes:>	Only Pt Codes or All Codes	Either only point codes or all codes of the job codelist will be available in the choicelist for <Code:>/<Point Code:> in a display mask ofan application program. Selecting a line/area code opens a new line/area.
<String Attrib:>	Choicelist	Available for <Show Codes: All Codes>. When this field is active, surveyed points that have the same code attached are strung to one line.

Next step

PAGE (F6) changes to the **Linework** page.

CONFIGURE Coding & Line- work, Linework page

The flags for Linework are defined on this screen.

The flags defined on this screen are linked to the options available for <Linework:> in a display mask of an application program. The selection for <Linework:> in a display mask determines the flag stored with a point. The availability of <Linework:> in a display mask is configured in **CONFIGURE Define Display Mask n**.

Description of fields

Field	Option	Description
<Begin Line:>	User input	Opens a new line when the next point is stored. Any lines which are currently open are closed. The point may or may not be stored with a point code.
<3pt Curve:>	User input	Stores the linework flag for a curve through three points and continues a line/area.
<ReOpen Last Line:>	User input	Opens the last used line again.
<End Line:>	User input	Closes all open lines.
<Cont Line/Area:>	User input	Indicates a line/area is open.
<Start Spline:>	User input	Stores the linework flag for beginning a spline and continues any open line/area.
<End Spline:>	User input	Stores the linework flag to stop a spline.
<Cont Spline:>	User input	Indicates a line/area is open with spline line type.
<Begin Area:>	User input	Opens a new area when the next point is stored. Any areas which are currently open are closed. The point may or may not be stored with a point code.
<ReOpen Last Area:>	User input	Opens the last used area again.
<Close Area:>	User input	Closes all open areas.

Next step

CONT (F1) returns to the screen from where **CONFIGURE Coding & Linework** was accessed.

17.4 Quality Control Settings

Description The settings on this screen define the limits for coordinate quality and DOP values accepted for point occupations.

Access Select **Main Menu: Config...\Survey Settings...\Quality Control Settings.**

**CONFIGURE
Quality Control
Settings**

Description of fields

Field	Option	Description
<CQ Control:>	None, Pos Only, Height Only or Pos & Height	The type of coordinate quality to be checked before storing a point. If activated, the limit defined in <Maximum CQ:> is checked before storing a point.
<Maximum CQ:>	User input	Available unless <CQ Control: None>. The maximum acceptable coordinate quality.
<DOP Limit:>	None, GDOP, PDOP, HDOP or VDOP	If activated, the limit defined in <Maximum DOP:> is checked. GPS positions are unavailable when the limit is exceeded.
<Maximum DOP:>	User input	Available unless <DOP Limit: None>. The maximum acceptable DOP value.
<Allow 2D Posn:>	Yes No	2D positions can be obtained with only three satellites available. The height is fixed to that of the last position computed with height. 2D positions cannot be obtained with only three satellites available.

Next step
CONT (F1) returns to the screen from where **CONFIGURE Quality Control Settings** was accessed.

17.5 Logging of Raw Obs

Description

Logged raw observations are used for

- static and kinematic operations. With these operations, raw data is always post-processed in the office. Raw data must therefore be logged on both reference and rover receivers.
 - real-time operations
 - to check the work in the office by post-processing.
- OR
- to fill in gaps when a real-time position could not be calculated in the field. This can happen due to problems with the real-time data reception.

Observations must be logged on all receivers which will be used for post-processing.

Access

Select **Main Menu: Config...\Survey Settings...\Logging of Raw Obs.**

CONFIGURE Logging of Raw Obs

11:42
CONFIGURE
Logging of Raw Obs
Log Raw Obs : If Radio Down
Log After : 5 s
For Minimum : 5 min
Log Rate : 5.0 s

CONT (F1)

To accept changes and return to the screen from where this screen was accessed.

FILES (F6)

Available unless **<Log Raw Obs: Never>** or **<Log Raw Obs: No>**. To configure the files for raw observations.

Quit ↑
CONT FILES

Description of fields

Field	Option	Description
<Log Raw Obs:>	Never, Static Only or Static & Moving	Available unless <R-Time Mode: Reference> . Determines if raw observation are logged and during what circumstances they are logged.
	If Radio Down	Available for <R-Time Mode: Rover> . Continuous raw observation logging during static and moving intervals when no real-time corrections are being received by a receiver.
	Yes or No Available	for <R-Time Mode: Reference> . Determines if the reference logs raw observations.
<Log After:>	User input	Available for <Log Raw Obs: If Radio Down> . Raw data logging begins after the specified time if radio contact is lost.
<For Minimum:>	User input	Available for <Log Raw Obs: If Radio Down> . Raw data logging continues for the specified time, also after the radio link is regained.

Field	Option	Description
<Log Rate:>	From 0.05s to 300.0s	Rate at which raw observations are logged. The maximum logging rate using Bluetooth on RX1250 is 0.2 s.

Next step

IF files for raw observations	THEN
are not to be configured	CONT (F1) closes the screen and returns to the screen from where CONFIGURE Logging of Raw Obs was accessed.
are to be configured	FILES (F6) . Refer to paragraph "CONFIGURE Raw Observation Files".

CONFIGURE Raw Observation Files

Description of fields

Field	Option	Description
<Use Separate Files:>	Yes or No	Stores all raw observations into one or into separate files.
<Obs File Size:>	From 1m in to 24 hours	Available for <Use Separate Files: Yes> . Splits the recorded data up into files of a specific period of time.
<Split Tracks:>	Yes or No Available	Available for <Use Separate Files: Yes> and unless <R-Time Mode: Reference> . Activates the interruption of static intervals when the time set for <Obs File Size:> is reached. The data is then recorded to a new file. Moving intervals are always interrupted and written to a new file when the time set for <Obs File Size:> is reached.
<Delete Old Files:>	Yes or No Available	Available for <Use Separate Files: Yes> . Deletes the recorded data after a specified period of time.
<When Older Than:>	From 1 day to 30 days	Available for <Delete Old Files: Yes> . The period of time after which the recorded data is deleted.

Next step

Step	Description
1.	CONT (F1) returns to CONFIGURE Logging of Raw Obs .
2.	CONT (F1) returns to the screen from where CONFIGURE Logging of Raw Obs was accessed.

17.6 Point Occupation Settings

Description

The settings on this screen define the way in which points are occupied and recorded.

Access

Select **Main Menu: Config...\Survey Settings...\Point Occupation Settings**.

CONFIGURE Point Occupation Settings

CONT (F1)

To accept changes and return to the screen from where this screen was accessed.

PARAM (F3)

To configure the time interval after which a point occupation can be stopped automatically. Refer to paragraph "CONFIGURE Post-Process Stop Criteria".

Description of fields

Field	Option	Description
<Pt Occupation:>	Normal	Records observations between pressing OCCUPY (F1) and STOP (F1) .
	Instantaneous	Records the time tag when OCCUPY (F1) is pressed. A coordinate is interpolated between the positions at the neighbouring two epochs to filter out effects of slight movement.
<Auto OCCUPY:>	No	Available for <Pt Occupation: Normal>. Starts point occupation when pressing OCCUPY (F1) .
	Yes	Starts point occupation automatically when entering SURVEY Survey: Job Name . All subsequent points must be occupied by pressing OCCUPY (F1) .
	Timed	Starts point occupation automatically at a certain time. The start time is specified in SURVEY Survey: Job Name .
<Auto STOP:>	Yes or No Available	Available for <Pt Occupation: Normal>. Stops the measurements automatically when the parameter defined for <STOP Criteria:> reaches 100 %.

Field	Option	Description
<STOP Criteria:>	Choicelist	Available for <Pt Occupation: Normal> and <Auto STOP: Yes>. Defines the method used for <Auto STOP:>. The setting determines the computation and value to be shown for <% Completed:> in the display mask and in STATUS Occupation Information .
<% Indicator:>	Choicelist	Available for <Pt Occupation: Normal> and <Auto STOP: No>. The setting determines the computation and value to be shown for <% Completed:> in the display mask and in STATUS Occupation Information . This is an indicator when to stop the point occupation.
<Beep On STOP:>	Yes or No	Activates that a beep is made when the point occupation is ended by <Auto STOP:>.
<Auto STORE:>	Yes or No	Stores points automatically after stopping the point occupation.
<Beep On STORE:>	Yes or No	Activates that a beep is made when the point is stored by <Auto STORE:>.
<End Survey:>	Manual Automatically Auto & Turn Off	Available for <Pt Occupation: Normal>. Exits SURVEY when pressing ESC . Exits SURVEY automatically when pressing STORE (F1) and returns to main menu. Exits SURVEY automatically when pressing STORE (F1) and turns receiver off.

Next step

IF parameters for <Auto STOP:>	AND	THEN
are not to be configured	-	CONT (F1) closes the screen and returns to the screen from where CONFIGURE Point Occupation Settings was accessed.
are to be configured	<R-Time Mode: None>	PARAM (F3) changes to CONFIGURE Post-Process Stop Criteria . Refer to paragraph "CONFIGURE Post-Process Stop Criteria".

IF parameters for <Auto STOP:>	AND	THEN
are to be configured	<R-Time Mode: Rover>	PARAM (F3) changes to CONFIGURE Real-Time Stop Criteria . Refer to paragraph "CONFIGURE Real-Time Stop Criteria".

CONFIGURE Post-Process Stop Criteria

Description of fields

The parameters shown on this screen depend on the setting for <STOP Criteria:> in **CONFIGURE Point Occupation Settings**.

Field	Option	Description
<Time at Point:>	User input	Sets the required observation time for each point. Counting time starts when OCUPY (F1) is pressed.
<Number of Obs:>	User input	Sets the required number of observations that should be recorded at each point. Counting observations starts when OCUPY (F1) is pressed.
<At Logging Rate:>	Output	Displays the rate at which static raw observations are logged as configured in CONFIGURE Logging of Raw Obs .
<n satellites for:>	User input	Sets the required observation time depending on the number of satellites available. Counting time starts when OCUPY (F1) is pressed. The receiver stops measuring when the set length of time for a certain number of satellites is reached. Should the number of available satellites change during observation, the observations already recorded will be taken into account.

Next step

Step	Description
1.	CONT (F1) closes the screen.
2.	CONT (F1) returns to the screen from where CONFIGURE Point Occupation Settings was accessed.

**CONFIGURE
Real-Time Stop
Criteria**

Description of fields

The parameters shown on this screen depend on the setting for **<STOP Criteria:>** in **CONFIGURE Point Occupation Settings**.

Field	Option	Description
<Pos Quality <:> and <Ht Quality <:>	User input	Sets the maximum position and height qualities for each point occupation. Calculating the qualities starts when OCUPY (F1) is pressed. The receiver stops measuring when the position and height qualities are both less than the configured values.
<Positions:>	User input	Raw data is logged for a minimum number of positions even when the <Pos Quality <:> and <Ht Quality <:> is already less than the specified maximum.
<Position Update:>	Output	Displays the value for <Position and Screen Update:> as configured in CONFIGURE Display Settings .
<No. of Positions:>	User input	Sets the number the positions which must be observed before the receiver stops measuring.

Next step

Step	Description
1.	CONT (F1) returns to CONFIGURE Point Occupation Settings .
2.	CONT (F1) returns to the screen from where CONFIGURE Point Occupation Settings was accessed.

18.1 Antenna & Antenna Heights

Description The settings on this screen define the antenna and the default height for the antenna.

Access Select **Main Menu: Config...\Instrument Settings...\Antenna & Antenna Heights**.

**CONFIGURE
Antenna & Antenna
Heights**

Description of fields

Field	Option	Description
<Antenna:>	Choicelist	Antennas in the receiver's System RAM or as defined in Main Menu: Manage...\Antennas .
<Default Ht:>	User input	Sets the default antenna height for the current configuration. The antenna height can still be changed during a survey. The change will not update <Default Ht:> in the configuration.
<Vert Offset:>	Output	The vertical antenna offset for the selected antenna.
<Meas Type:>	Slope or Vertical	The way the antenna height will be measured.
<Horiz Offset:>	Output	Available for <Meas Type: Slope>. The horizontal antenna offset for the selected antenna.
<Moving Ht:>	User input	Sets the default antenna height for auto points and for the moving part of a track when logging raw observations.

Next step

CONT (F1) returns to the screen from where **CONFIGURE Antenna & Antenna Heights** was accessed.

18.2 Satellite Settings

Description The settings on this screen define which satellite system (available for GX1230 GG/ATX1230 GG), satellites and satellite signals will be used by the receiver.

Access Select **Main Menu: Config...Instrument Settings...Satellite Settings**.

CONFIGURE Satellite Settings

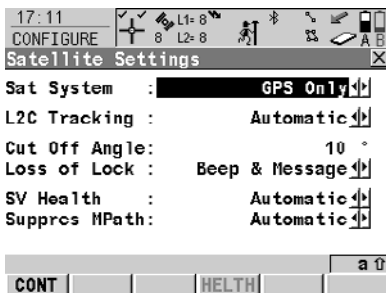

CONT (F1)

To accept changes and return to **GPS1200 Main Menu**.

HEALTH (F4)

Available for **<SV Health: User Defined>**. To configure the satellites used in the survey.

Description of fields

Field	Option	Description
<Sat System:>	GPS Only GPS & Glonass	Available for GX1230 GG/ATX1230 GG. Defines the satellite signals accepted by the receiver when tracking satellites. Only GPS satellites are tracked. GPS and GLONASS satellites are tracked.
<L2C Tracking:>	Automatic or Always Track	Available for GX1230 (serial numbe > 465000)/ATX1230 (serial number > 160000)/GX1230 GG/ATX1230 GG. Defines if the L2C signal will be tracked. The recommended setting is Automatic .
<Cut Off Angle:>	User input	Sets the elevation in degrees below which satellite signals are not recorded and are not shown to be tracked. Recommended settings: For real-time: 10°. For purely post-processing applications: 15°.
<Loss of Lock:>	Beep & Message or No Beep/Message	Activates an acoustic warning signal and a message given by the receiver when satellites are lost and therefore no position can be computed.
<SV Health:>	Automatic User Defined	Incoming satellite signals are monitored by the receiver. Data from signals which are flagged as unhealthy are neither recorded nor used for real-time computations. Satellites must manually be included/excluded from data recording and real-time computations with HEALTH (F4) .

Field	Option	Description
<Suppress MPath:>	Automatic or Always On	Available for GX1230 GG/ATX1230 GG. Defines if phase multipath mitigation techniques will be used. The recommended setting is Automatic .

Next step

CONT (F1) closes the screen and returns to **GPS1200 Main Menu**.

18.3 Time Zone

Description

The settings on this screen help the receiver to quickly locate and track satellites.

Access

Select **Main Menu: Config...Instrument Settings...Time Zone.**

CONFIGURE

Local Time Zone

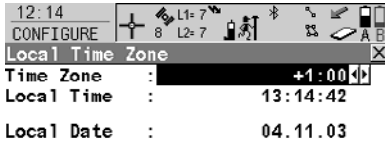

CONT (F1)

To accept changes and to return to **GPS1200 Main Menu.**



18.4 Instrument ID

Description

The settings on this screen define the instrument identification number. This number is used for the generation of the file names. Using format files, the instrument ID can be output together with data from the instrument. This means that it can be identified which instrument was used for certain measurements.

Access

Select **Main Menu: Config...Instrument Settings...Instrument ID.**

**CONFIGURE
Instrument ID**

Description of fields

Field	Option	Description
<Instrument ID:>	User input	Sets a four digit number as instrument identification number. By default the last four numbers of the serial number are used.

Next step

CONT (F1) returns to **GPS1200 Main Menu.**

19.1 Wizard Mode

Description The settings on this screen define the behaviour of the configuration set wizard.

Access Select **Main Menu: Config...\General Settings...Wizard Mode**.

**CONFIGURE
Wizard Mode**



CONT (F1)

To accept changes and to return to **GPS1200 Main Menu**.

LIST (F6)

To list all screens within a configuration set. Allows to access these individual screens and change settings.



Description of fields

Field	Option	Description
<Wizard Mode:>	View All Screens	All configuration screens are shown in the configuration set wizard. Application program configuration screens are not included. They can be configured within each application program.
	Reduced	A reduced set of screens are shown in the configuration set wizard.

Next step

CONT (F1) returns to **GPS1200 Main Menu**.

19.2 Hot Keys & User Menu

Description

The settings on this screen assign a particular function, screen or application program to each of the first and second level of hot keys and to the **USER** key.

Access

Select **Main Menu: Config...\General Settings...\Hot Keys & User Menu**.

**CONFIGURE
Hot Keys & User
Menu****Description of fields**

Field	Option	Description
<F7:> to <F12:>	Choicelist	Available on the Hot Keys page and the Shift Hot Keys page. All functions, screens or application programs which can be assigned to the particular key.
<1:> to <9:>	Choicelist	Available on the User Menu page. All functions, screens or application programs which can be assigned to the individual lines in the user defined menu.

Next step

PAGE (F6) changes to another page on this screen.

19.3 Units & Formats

Description

The settings on this screen define

- the units for all types of measurement data displayed.
- information related to some types of measurement data.
- the order in which coordinates are displayed.

Access

Select **Main Menu: Config...\General Settings...Units & Formats.**

CONFIGURE

Units & Formats, Units page

Description of fields

Field	Option	Description
<Distance Unit:>	Metre (m), Int Ft (fi), Int Ft/Inch (fi), US Ft (ft), US Ft/Inch (ft), US Miles (mi) or Kilometres (km)	The units shown for all distance and coordinate related fields.
<Distance Dec:>	From 0 Decimals to 4 Decimals	The number of decimal places shown for all distance and coordinate related fields. This is for data display and does not apply to data export or storage.
<Angle Unit:>	400 gon, 360 ° ' ", 360° dec or 6400 mil	The units shown for all angular and coordinate related fields. More angle settings can be defined on the Angle page.
<Angle Dec:>	Choicelist	The number of decimal places shown for all angular and coordinate related fields. This is for data display and does not apply to data export or storage.
<Grade Unit:>	h:v v:h % (v/h * 100) Elev Angle	The input and output format for grades. Horizontal by vertical distance. Vertical by horizontal distance. Percentage of vertical by horizontal distance. Elevation angle.
<Velocity Unit:>	Km/h (kmh), Mph (mph) or Knots (kn)	The units shown for all velocity related fields.
<Area Unit:>	m², Int Acres (Ai), US Acres (A), Hectares (ha), fi² or ft²	The units shown for all area related fields.
<Volume Unit:>	m³, fi³, ft³, or yd³	The units shown for all volume related fields.
<Temp Unit:>	Celsius (°C) or Fahrenheit (°F)	The units shown for all temperature related fields.

Field	Option	Description
<Press Unit:>	mbar, mmHg, Inch Hg (inHg), hPa or psi	The units shown for all pressure related fields. PSI = pounds per square inch.

Next step

PAGE (F6) changes to the **Angle** page.

**CONFIGURE
Units & Formats,
Angle page**

Description of fields

Field	Option	Description
<Direc Ref:>	North Azimuth, South Azimuth, North Anticlock or Bearing	Sets the reference direction as well as the direction from where and how azimuths are computed.
<Direc Base:>	True or Magnetic	Sets the North direction.
<Mag Declin:>	User input	Available for <Direc Base: Magnetic>. The value for the magnetic declination. It is considered when computing or using any azimuth values.

Next step

PAGE (F6) changes to the **Time** page.

**CONFIGURE
Units & Formats,
Time page**

Description of fields

Field	Option	Description
<Time Format:>	24 hour or 12 hour (am/pm)	How the time is shown in all time related fields.
<Date Format:>	Day.Month.Year, Month/Day/Year or Year/Month/Day	How the date is shown in all date related fields.

Next step

PAGE (F6) changes to the **Format** page.

**CONFIGURE
Units & Formats,
Format page**

Description of fields

Field	Option	Description
<Grid Format:>	East,North or North,East	The order in which grid coordinates are shown in all screens. The order in display masks depends on the user settings.

Field	Option	Description
<Geodetic Format:>	Lat,Long or Long,Lat	The order in which geodetic coordinates are shown in all screens. The order in display masks depends on the user settings.

Next step

PAGE (F6) changes to the first page on this screen.

19.4 Language

Description

The setting on this screen defines the language used on the instrument. Three languages can be stored on the receiver at one time - English and two others. English cannot be deleted.

Access

Select **Main Menu: Config... \General Settings... \Language**.

CONFIGURE Languages on Instrument

Description of columns

Field	Description
Language	The languages available on the receiver. The selected language is used for the system software. If a language is not available for the system software, the English language is used instead. Application programs run in the language they were loaded.

Next step

CONT (F1) returns to **GPS1200 Main Menu**.

19.5 Display, Beeps, Text

Description

The settings on this screen allow the screen appearance to be configured, turn the notification beeps on and off and define the behaviour of the keys. The settings are stored on the RX1200 itself. If RX1200's are exchanged, the settings stored on the new RX1200 apply.

Access

Select **Main Menu: Config...General Settings...Display, Beeps, Text.**

CONFIGURE Display, Beeps, Text, Display page

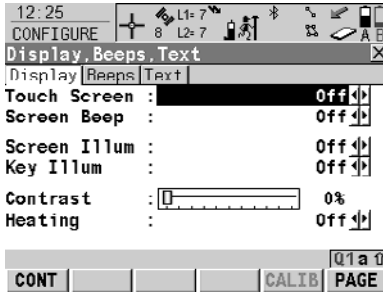

CONT (F1)

To accept changes and return to **GPS1200 Main Menu.**

CALIB (F5)

To calibrate the touch screen.

Description of fields

Field	Option	Description
<Touch Screen:>	On or Off	Turns touch screen on and off.
<Screen Beep:>	Off, Soft or Loud	Controls the beep upon touching the touch screen.
<Screen Illum:>	Off, Always On, On for 1 min, On for 2 min or On for 5 min	Controls the screen illumination to be on, off or on for the specified time after the last key was pressed, or touch screen event.
<Key Illum:>	Off, Same as Screen or Always On	Controls the keyboard illumination.
<Contrast:>	From 0% to 100%	Adjust the contrast level for the display with the right and left arrow key when the field is highlighted or using the supplied stylus on the slider.
<Heating:>	Automatic Off	The screen heating comes on automatically at 5°C and shuts off again at 7°C. The screen heating never comes on.

Next step

PAGE (F6) changes to the **Beeps** page.

CONFIGURE
Display, Beeps,
Text,
Beeps page

Description of fields

Field	Option	Description
<Warning Beeps:>	Off, Soft or Loud	Controls the beep for acoustic warning signals.
<Key Beeps:>	Off, Soft or Loud	Controls the beep upon key presses on the RX1200.

Next step

PAGE (F6) changes to the **Text** page.

CONFIGURE
Display, Beeps,
Text,
Text page

Description of fields

Field	Option	Description
<Deflt aNum:>	Choicelist	Sets the set of extra characters available through aNUM or F1-F6 whenever an entry is made. The choices available depend on the character sets loaded on the instrument and the language configured to be used on the instrument.

Next step

PAGE (F6) changes to the first page on this screen.

19.6 Start Up & Power Down



Power Down is unavailable for a RX1250 with SmartAntenna.

Description

The settings on this screen

- define the behaviour of the instrument for a general start up.
- define the behaviour of the instrument when starting up after a power loss.
- define a PIN code which needs to be typed in on starting up the receiver. A PIN is a **Personal Identification Number**.

Access

Select **Main Menu: Config...\General Settings...\Start Up & Power Down**.

CONFIGURE

Start Up & Power Down,
Start Up page

Description of fields

Field	Option	Description
<Start Screen:>	Choicelist	Determines the screen entered after turning on the receiver.
<Port 1:> <Port 2:> <Port 3:>	Yes or No	Determines if the receiver powers up when a pulse is received at one of the ports. The fields are unavailable for RX1250 with SmartAntenna.

Next step

PAGE (F6) changes to the **Power Down** page.

CONFIGURE

Start Up & Power Down,
Power Down page

This page is not available for RX1250 with SmartAntenna.

Description of fields

Field	Option	Description
<Recovery:>	Sudden Loss Only	The receiver turns itself back on automatically once power is restored after a sudden power loss.
	Always	The receiver turns itself back on automatically once power is restored after a sudden power loss or after gradual power loss. The receiver returns to the screen in which it was operating when the power failed.
<Set Primary:>	External A, External B or Automatic	Available for the GRX1200 Series where batteries can be attached to port PWR with a Y-cable. Sets the external battery which is always used when sufficient power is available, regardless of the status of the other battery. Primary power sources must provide a minimum voltage of 11.4 V.

Next step

PAGE (F6) changes to the **PIN Code** page.

CONFIGURE Start Up & Power Down, PIN Code page

The appearance of the screen varies with the setting for **<Use PIN:>** when this screen is accessed.

<Use PIN: No>

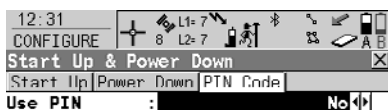

New PIN : -----

<Use PIN: Yes>

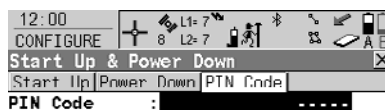

Use PIN : Yes

Change PIN : No

New PIN : -----



Description of fields

Field	Option	Description
Use PIN	Yes or No	Activates the PIN code protection. This setting is not part of the configuration set.
New PIN	User input	The PIN code must be a number with four to six digits.
PIN Code	User input	The PIN code as previously defined on this page. The correct PIN code must be typed in within five attempts or the PUK code is required
Change PIN	Yes or No	Activates <New PIN:> to type in a new PIN code.

Next step

PAGE (F6) changes to the first page on this screen.

20.1 Overview

Description

The receiver has a variety of interfaces which can be configured to be used with different ports and devices. The configuration varies depending on the individual application.

Interface, port and device

Description of the technical terms

Technical term	Description	Example
Interface	An interface should be considered as a function of the receiver.	Real-Time
Port	The physical port on the instrument which will be used for the interface functionality. It is sometimes necessary to use particular ports with certain interfaces.	Port P1
Device	The hardware which is connected to the chosen port.	Radio

Access

Select **Main Menu: Config...Interfaces...**

CONFIGURE Interfaces

The screen gives an overview of all interfaces with the currently assigned port and device. If a second real-time interface is configured it will also be shown.

The screenshot shows the 'CONFIGURE Interfaces' screen. At the top, there is a status bar with the time '12:38' and various icons. Below that is a 'CONFIGURE' header with a crosshair icon and 'L1=7', 'L2=7'. The main title is 'Interfaces'. Below the title is a table with columns 'Interface', 'Port', and 'Device'. The 'Real-Time' interface is highlighted in black with white text, showing '1' in the Port column and 'Satellite 3AS' in the Device column. Other interfaces listed include 'ASCII Input', 'NMEA Out 1', 'NMEA Out 2', 'Export Job', 'Hidden Pt', 'T11t', and 'Meteo'. At the bottom of the screen, there are four buttons: 'CONT', 'EDIT', 'CTRL', and a button with 'Q1a' and a cursor icon.

Interface	Port	Device
Real-Time	1	Satellite 3AS
ASCII Input	-	-
NMEA Out 1	-	-
NMEA Out 2	-	-
Export Job	-	-
Hidden Pt	-	-
T11t	-	-
Meteo	-	-

CONT (F1)

To return to the screen from where this screen was accessed.

EDIT (F3)

To configure the parameters related to the highlighted interface. Refer to the sections on each individual interface below.

CTRL (F4)

Available for certain devices connected to certain interfaces. To configure additional parameters, for example changing channels of radios.

SHIFT CONEC (F4) and SHIFT DISCO (F4)

Available for a real-time interface configured to use a device of type digital cellular phone or modem. To dial the number of another station configured in the active configuration set and to hang up again.

Description of columns

Column	Option	Description
Port	1, 2 or 3	The physical port P1,P2 or P3on the instrument which will be used for the interface functionality.
	BT x	The Bluetooth port which will be used for the interface functionality. Available for RX1250.
	Clip	Clip-on-contacts on RX1250. It is used for RX1250 with GHT56 when a device is attached to the GHT56.
	NETx	The logical NET port which will be used for the interface functionality. Available for an activated Internet interface.
Device	<Port x>	Default device for the physical ports P1, P2 and P3.
	<Clip-on>	Default device for the physical LEMO pot on the GHT56. It is displayed for RX1250 with GHT56 when <Port: Clip-on> is selected.

Next step

CONT (F1) returns to the screen from where this screen was accessed.

20.2 Real-Time

20.2.1 Overview

Description

The real-time interface allows real-time related parameters to be configured. This includes defining if the receiver should work as a reference or a rover and the real-time messages to be used. Up to two real-time interfaces can be configured on the receiver.

20.2.2 Configuration without Real-Time Interface

Access

Select **Main Menu: Config...\Interfaces....** Highlight **Real-Time. EDIT (F3)**.

CONFIGURE Real-Time Mode

<**R-Time Mode: None**> means the receiver is not to be used as a real-time reference or as a real-time rover.

Next step

IF a Space-Based Augmentation System	THEN
needs to be configured	SHIFT SBAS (F5) to access CONFIGURE SBAS Tracking Mode .
does not need to be configured	CONT (F1) returns to the screen from where CONFIGURE Real-Time Mode was accessed.

20.2.3 Configuration of a Reference Real-Time Interface

Access

Select **Main Menu: Config...Interfaces....** Highlight **Real-Time**. **EDIT (F3)**.

CONFIGURE

Real-Time Mode

The available fields and keys on this screen depend on the selected settings.



CONT (F1)

To accept changes and return to the screen from where this screen was accessed.

REF (F2)

To configure additional settings relevant to reference, e.g. time slicing.

RATES (F3)

To configure the data rates for the selected real-time data format.

SRCH (F4)

Available on RX1250 with **<Port: Bluetooth x>** and a Bluetooth device being selected. To search for all available Bluetooth devices. If more than one Bluetooth device is found a list of available devices is provided.

DEVCE (F5)

Available unless **<Port: NETx>**. To create, select, edit or delete a device.

SHIFT RT-2 (F2)

To accept the settings and configure a second reference real-time interface.

SHIFT SBAS (F5)

To configure the Space-Based Augmentation System to be used.



Two real-time devices can be attached to two different ports, for example a radio and a digital cellular phone. On the reference, the two devices can operate simultaneously. Press **SHIFT RT-2 (F2)** to configure a second real-time interface.

Description of fields

Field	Option	Description
<R-Time Mode:>	None, Reference or Rover	<R-Time Data: Reference> activates a reference real-time interface.
<R-Time Data:>	Leica	The proprietary Leica real-time GPS data format. This is recommended when working exclusively with Leica receivers.
	CMR CMR+	CMR and CMR+ are compacted formats used to broadcast data for third party receivers.

Field	Option	Description
		Use RTCM when rover units from a different manufacturer are to be used.
	RTCM v3	Message according to RTCM version 3. Higher efficiency than RTCM v2.x. Supports real-time services with significantly reduced bandwidth. For real-time GPS operation and network operations according to Master-Auxiliary Concept.
	RTCM 1,2 v2	Message according to RTCM version 2.x. Differential and delta differential GPS corrections. Message 3 is also generated. Use for DGPS applications. Accuracy at the rover: 0.25 - 1 m rms.
	RTCM 9,2 v2	Message according to RTCM version 2.x. GPS partial correction set and delta differential GPS corrections. Message 3 is also generated. Use for DGPS applications with a slow data link in the presence of interference. Accuracy at the rover: 0.25 - 1 m rms.
	RTCM 18,19 v2	Message according to RTCM version 2.x. Uncorrected carrier phase and pseudorange. Message 3 is also generated. Use for real-time operations where the ambiguities will be resolved at the rover. Accuracy at the rover: 1 - 5 cm rms after a successful ambiguity resolution.
	RTCM 20,21 v2	Message according to RTCM version 2.x. Real-time carrier phase corrections and high-accuracy pseudorange corrections. Message 3 is also generated. Use for real-time operations. Accuracy at the rover: 1 - 5 cm rms after a successful ambiguity resolution.
	RTCM 1,2,18,19 v2	Message according to RTCM version 2.x. Combination of RTCM 1,2 v2 and RTCM 18,19 v2 .
	RTCM 1,2,20,21 v2	Message according to RTCM version 2.x. Combination of RTCM 1,2 v2 and RTCM 20,21 v2 .
<Port:>	Bluetooth x	Available for RX1250. The Bluetooth port which will be used for the interface functionality.
	Clip-on	Available for RX1250. The clip-on-contacts. It is used for RX1250 with GHT56 when a device is attached to the GHT56.
	NETx	Available for an activated Internet interface. If these ports are not assigned to a specific interface, then these ports are additional remote ports.

Field	Option	Description
	Port x	The physical port P1, P2 or P3 on the instrument to which the device is attached.
	Port 1	Available for RX1250. LEMO port on RX1250.

Next step

REF (F2) changes to **CONFIGURE Additional Reference Options, General** page.

**CONFIGURE
Additional Reference
Options,
General page**

Description of fields

Field	Option	Description
<Ref Stn ID:>	User input	An identification for a reference station. It is converted into a compact format and sent out with real-time data in all real-time data formats. It is different from the point ID of the reference station. An ID of the reference station is required if working with several reference stations in time slicing mode on the same frequency. In this case, the ID of the reference station from which data is to be accepted must be typed in at the rover.
<Time Slicing:>	Yes or No	The possibility to send real-time messages delayed. This is required when real-time messages from different reference stations are sent on the same radio channel. Time slicing works for all device types.
<Used Ref Stations:>	2, 3 or 4 Available	for <Time Slicing: Yes> . The number of reference stations in use from where real-time messages are sent.
<Time Slot:>	2, 3 or 4 The contents of the choicelist depends on the settings for <Used Ref Stations:> .	Available for <Time Slicing: Yes> . The time slot represents the actual time delay. The number of possible timeslots is the number of reference stations in use. The time delay equals 1 s divided by the total number of reference stations.
<End of Message:>	Nothing or CR	To add a Carriage Return at the end of the real-time message.
<RTCM Version:>	2.1, 2.2 or 2.3 Available	for <R-Time Data: RTCM XX v2> in CONFIGURE Real-Time Mode . The same version must be used at the reference and the rover.

Next step

PAGE (F6) changes to the **NTRIP** page.

**CONFIGURE
Additional Reference Options,
NTRIP page**

Description of fields

Field	Option	Description
<Use NTRIP:>	Yes or No	Activates NTRIP.
<Password:>	User input	A password for authentication is required to send data to the NTRIP Caster. Contact the NTRIP administrator for information.
<Mountpnt:>	User input	Identifies from where data is streamed to the NTRIP Caster.

Next step

Step	Description
1.	CONT (F1) closes the screen and returns to CONFIGURE Real-Time Mode .
2.	RATES (F3) . Refer to paragraph "CONFIGURE Real-Time Data Rates".

**CONFIGURE
Real-Time Data Rates**

Description

For all real-time data formats, parts of the message can be output at different rates. The settings on this screen define the output rates for the various parts of the selected real-time data format. The available fields on this screen depend on the selected setting for **<R-Time Data:>** in **CONFIGURE Real-Time Mode**.

Description of fields

Field	Option	Description
<Data:>	From 0.1s to 60.0s	Rates for the transmission of raw observations. The default settings are suitable for standard applications.
<Coords:>	From 10s to 120s	Rate for the transmission of reference coordinates.
<Messages:>	Choicelist	Available for <RTCM Version: 2.3> in CONFIGURE Additional Reference Options, General page. The messages sent within the coordinate message.
<Info:>	From 10s to 120s	Rate for the transmission of reference station information such as point ID.
<Msge Type:>	Choicelist	The message type of <R-Time Data: RTCM v3> . <Msge Type: Compact> is suitable for standard applications.

Next step

Step	Description
1.	CONT (F1) closes the screen and returns to CONFIGURE Real-Time Mode .
2.	SHIFT RT-2 (F2) changes to CONFIGURE Real-Time Mode (2) . Refer to paragraph "CONFIGURE Real-Time Mode (2)".

CONFIGURE Real-Time Mode (2)

Description

The second real-time interface is completely independent from the first one. All settings can be configured differently. The port that is used must be different to the first real-time interface.

Refer to paragraph "CONFIGURE Real-Time Mode" above for information on the fields and keys. The difference is, that **SHIFT RT-2 (F2)** is replaced by **SHIFT RT-1 (F2)** and returns to **CONFIGURE Real-Time Mode**.

Next step

CONT (F1) accepts the changes, closes the screen and returns to the screen from where **CONFIGURE Real-Time Mode** was accessed.

20.2.4 Configuration of a Rover Real-Time Interface

Access

Select **Main Menu: Config...Interfaces....** Highlight **Real-Time. EDIT (F3)**.

CONFIGURE Real-Time Mode

The available fields and keys on this screen depend on the selected settings.

11:42

CONFIGURE Real-Time Mode

R-Time Mode: Rover

R-Time Data: Leica

Port: Port 1

Device: Satellite 3AS

Ref Sensor: GX1230

Ref Antenna: AX1202 Tripod

CONT ROVER DEVCE Q1 a ↑

CONT (F1)

To accept changes and return to the screen from where this screen was accessed.

ROVER (F2)

To configure additional settings relevant to rover operations. Available unless a SBAS data format has been selected for **<R-Time Data>**.

SRCH (F4)

Available on RX1250 with **<Port: Bluetooth x>** and a Bluetooth device being selected. To search for all available Bluetooth devices. If more than one Bluetooth device is found a list of available devices is provided.

DEVCE (F5)

To create, select, edit or delete a device. Available unless a SBAS data format has been selected for **<R-Time Data>**.

SHIFT PRED (F3)

To activate and deactivate the prediction of real-time observations between the data rate of the reference. Available unless **<R-Time Data: RTCM 1,2 v2>** or **<R-Time Data: RTCM 9,2 v2>**.

SHIFT FILT (F4)

To activate and deactivate the height filter for height smoothing. Available unless a SBAS data format has been selected for **<R-Time Data>**.

SHIFT SBAS (F5)

To configure the **Space-Based Augmentation System** to be used. The configuration of SBAS determines the options available for **<R-Time Data:>** in **CONFIGURE Real-Time Mode**.



Two real-time devices can be attached to two different ports, for example a radio and a digital cellular phone. Due to the nature of a rover, the two devices cannot operate simultaneously. It is recommended to choose two different configuration sets, one for each real-time device. Change the configuration set to change the active device.

Description of fields

Field	Option	Description
<R-Time Mode:>	None, Reference or Rover	<R-Time Data: Rover> activates a rover real-time interface.
<R-Time Data:>	Leica CMR/CMR+ RTCM v3 RTCM 1,2 v2 RTCM 9,2 v2 RTCM 18,19 v2 RTCM 20,21 v2 WAAS/EGNOS/MSAS, EGNOS, WAAS, MSAS, EGNOS (Test) or WAAS (Test)	Refer to "20.2.3 Configuration of a Reference Real-Time Interface" for information about these real-time data formats. The availability of the following options depend on the selection made for <SBAS Tracking:> in CONFIGURE SBAS Tracking Mode . Wide Area Augmentation System European Geostationary Navigation Overlay Service MTSAT Satellite-based Augmentation System where MTSAT stands for Multi-functional Transport SATellite
<Port:>	Bluetooth x Clip-on NETx Port x	Available for RX1250. The Bluetooth port which will be used for the interface functionality. Available for RX1250. The clip-on-contacts. It is used for RX1250 with GHT56 when a device is attached to the GHT56. Available for an activated Internet interface. If these ports are not assigned to a specific interface, then these ports are additional remote ports. The physical port P1, P2 or P3 on the instrument to which the device is attached.
<ID Address:>	Output	Available on RX1250 with <Port: Bluetooth x> and a Bluetooth device being selected. The ID address of the SmartAntenna to be used.
<Ref Sensor:>	Choicelist	The receiver type used at the reference. If the real-time data format does not contain the information of the receiver type certain corrections based on the information of the receiver type are applied in order to provide correct results. The real-time data formats Leica, CMR and CMR+ contain this information. This is mainly important when a System300 receiver is used as reference.

Field	Option	Description
<Ref Antenna:>	Choiclist	<p>The antenna used at the reference. If the real-time data format does not contain the information of the antenna certain corrections based on the information of the antenna are applied in order to provide correct results. The real-time data formats Leica, RTCM v2.3, CMR and CMR+ contain this information.</p> <p> If the reference data is corrected by absolute antenna calibration values and a Leica standard antenna is being used on the rover, select ADVNU-LANTENNA as reference antenna.</p>

Next step

ROVER (F2) accesses **CONFIGURE Additional Rover Options, General** page.

CONFIGURE Additional Rover Options, General page

The available fields depend on the selected <R-Time Data:> in **CONFIGURE Real-Time Mode**.

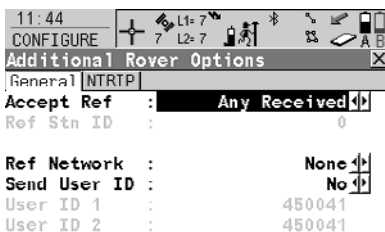

11:44
 CONFIGURE
 Additional Rover Options
 General | NTRIP
 Accept Ref : Any Received
 Ref Stn ID : 0
 Ref Network : None
 Send User ID : No
 User ID 1 : 450041
 User ID 2 : 450041
 CONT GGA PAGE

CONT (F1)

To accept changes and return to the screen from where this screen was accessed.

GGA (F4)

To activate the sending of a GGA message for reference network applications.

GETID (F5)

Available for <Accept Ref: User Defined>. To display and select the station ID of the available reference stations, the latency of the message and the data format. When using radios, the radio channel can be switched and the stations received on the new frequency are displayed.

1st (F6)

Available for <Accept Ref: First Received>. To force the system to try to establish a new connection with a different reference station.

Description of fields

Field	Option	Description
<Accept Ref:>	User Defined	Incoming real-time data is accepted from the reference station defined in <Ref Stn ID:> .
	First Received	Incoming real-time data from the first recognised reference station is accepted.
	Any Received	Incoming real-time data from any reference station is accepted.
<Ref Stn ID:>	User input	Available for <Accept Ref: User Defined> . The special ID of the reference station from which real-time data is to be received.
<Ref Network:>	None	Defines the type of reference network to be used. To survey without reference station network.
	Nearest	The rover sends its position via NMEA GGA message to LEICA GPS Spider. From this position, LEICA GPS Spider determines the reference in a reference network that is closest to the rover.
	i-MAX	The rover sends its position via NMEA GGA message to LEICA GPS Spider where the Master-Auxiliary corrections are calculated. The corrections are also individualised by LEICA GPS Spider, which means it determines the best suitable corrections for that rover.
	MAX	The rover typically does not send its position to LEICA GPS Spider. LEICA GPS Spider calculates and sends Master-Auxiliary corrections to the rover. The rover individualises the corrections for its position, which means it determines the best suitable corrections.
	VRS	If this option is selected, a NMEA GGA message must be activated using GGA (F4) .
	FKP	Area correction parameters.
<Send User ID:>	Yes or No	Activates the sending of a Leica proprietary NMEA message defining the user.
<User ID 1:> and <User ID 2:>	User input	Available for <Send User ID: Yes> . The specific user ID's to be sent as part of the Leica proprietary NMEA message. By default the serial number of the instrument is displayed.
<RTCM Version:>	1.x, 2.1, 2.2 or 2.3	Available for <R-Time Data: RTCM XX v2> in CONFIGURE Real-Time Mode . The same version must be used at the reference and the rover.

Field	Option	Description
<Bits / Byte:>	6 or 8	Defines the number of bits/byte in the RTCM message being received.

Next step

PAGE (F6) changes to the **NTRIP** page.

Description of fields

Field	Option	Description
<Use NTRIP:>	Yes or No	Activates NTRIP.
<User ID:>	User input	A user ID is required to receive data from the NTRIP Caster. Contact the NTRIP administrator for information.
<(cont):>	User input	Allows the <User ID:> string to continue onto a new line.
<Password:>	User input	A password is required to receive data from the NTRIP Caster. Contact the NTRIP administrator for information.
<Mountpnt:>	User input	The NTRIP Source from where real-time data is required. SRCE (F5) to download the NTRIP Source table if <Mountpnt:> is unknown.

Next step

Step	Description
1.	CONT (F1) returns to CONFIGURE Real-Time Mode .
2.	CONT (F1) returns to the screen from where CONFIGURE Real-Time Mode was accessed.

20.2.5 Configuration of SBAS

Description

Allows a **Space-Based Augmentation System** to be configured to provide additional corrections.

Access step-by-step

Step	Description
1.	Refer to "20.2.1 Overview" to access CONFIGURE Real-Time Mode .
2.	SHIFT SBAS (F5) to access CONFIGURE SBAS Tracking Mode .

CONFIGURE SBAS Tracking Mode

Description of fields

Field	Option	Description
<SBAS Tracking:>	Automatic SBAS	The Space-Based Augmentation System to use. The options available for <R-Time Data:> in CONFIGURE Real-Time Mode depend on the selection made here. SBAS satellites will be tracked and the SBAS service used will be automatically selected, including MSAS.
	WAAS, EGNOS or MSAS	Satellites of one of the following systems will be tracked: Wide Area Augmentation System European Geostationary Navigation Overlay System MTSAT Satellite-based Augmentation System
	EGNOS (Test)	To track European Geostationary Navigation Overlay System satellites while the system is still in test mode.
	WAAS (Test)	To track Wide Area Augmentation System satellites while the system is still in test mode.

Next step

Step	Description
1.	CONT (F1) returns to CONFIGURE Real-Time Mode .
2.	CONT (F1) returns to the screen from where CONFIGURE Real-Time Mode was accessed.

20.2.6 Configuration of GGA Message Sending for Reference Network Applications

Description

Most reference networks require an approximate position of the rover. For reference network applications, a rover dials into the reference network and submits its approximate position in form of a NMEA GGA message.

Access step-by-step

Step	Description
1.	Select Main Menu: Config...Interfaces...
2.	Highlight Real-Time .
3.	EDIT (F3)
4.	CONFIGURE Real-Time Mode <R-Time Mode: Rover>
5.	ROVER (F2) to access CONFIGURE Additional Rover Options .
6.	GGA (F5) to access CONFIGURE Send GGA NMEA .

CONFIGURE Send GGA NMEA



CONT (F1)

To accept changes and return to the screen from where this screen was accessed.

COORD (F2)

Available for <GGA Position: From Job> and <GGA Position: LAST/HERE Posn>. To view other coordinate types.

LAST (F3)

Available for <GGA Position: LAST/HERE Posn>. To use the same coordinates in the GGA message as when the receiver was last used in a reference network application.

HERE (F4)

Available for <GGA Position: LAST/HERE Posn>. To use the coordinates of the current navigation position in the GGA message.

SHIFT ELL H (F2) and SHIFT ORTH (F2)

Available for local coordinates. To change between the ellipsoidal and the orthometric height.

Description of fields

Field	Option	Description
<GGA Position:>	Automatic	The current rover position is sent to the reference network.
	From Job	For the position, a point from the active job can be selected in <Point ID:>.
	LAST/HERE Posn	The position last used in a reference network application or the current navigation position can be selected using LAST (F3) or HERE (F4) .
	None	No GGA message is sent to the reference network.
<Point ID:>	Choicelist	Available for <GGA Position: From Job>. The coordinates of this point are sent out as position in the GGA message.

Next step

Step	Description
1.	CONT (F1) returns to CONFIGURE Additional Rover Options .
2.	CONT (F1) returns to CONFIGURE Real-Time Mode .
3.	CONT (F1) returns to the screen from where CONFIGURE Real-Time Mode was accessed.

20.3 Hidden Point

Description

Hidden point measurement devices are used for measuring to points which cannot be directly measured with GNSS, for example house corners or trees. The measurements made with a hidden point measurement device are directly transferred to the receiver for the calculation of the coordinates of the hidden point. They can also be entered manually.



The configuration of hidden point measurements is possible for **<R-Time Mode: Rover>** and **<R-Time Mode: None>** in **CONFIGURE Real-Time Mode**.

Access

Select **Main Menu: Config...Interfaces....** Highlight **Hidden Pt. EDIT (F3)**.

CONFIGURE Hidden Point Measurements

CONT (F1)

To accept changes and return to the screen from where this screen was accessed.

OFSET (F2)

To configure the heighting and external angle offsets.

SRCH (F4)

Available on RX1250 with **<Port: Bluetooth x>** and a Bluetooth device being selected. To search for all available Bluetooth devices. If more than one Bluetooth device is found a list of available devices is provided.

DEVCE (F5)

To create, select, edit or delete a device.

Description of fields

Field	Option	Description
<Compute Ht:>	Yes or No	To compute a hidden point with height.
<Est Pos Qlty:>	User input	The estimated value for the position quality assigned to all hidden points.
<Est Ht Qlty:>	User input	Available for <Compute Ht: Yes> . The estimated value for the height quality assigned to all hidden points.
<Use Device:>	Yes or No	Activates the hidden point interface. For <Use Device: No> , the measured values must be entered manually.
<Port:>	Bluetooth x	Available for RX1250. The Bluetooth port which will be used for the interface functionality.
	Port x	The physical port P1,P2 or P3on the instrument to which the device is attached.

Field	Option	Description
	Port 1	Available for RX1250. LEMO port on RX1250.

Next step

OFSET (F2) to access CONFIGURE Hidden Pt Device Offsets.

**CONFIGURE
Hidden Pt Device
Offsets**

Description of fields

Field	Option	Description
<Height Offset:>	None	No height offsets are used. The result is the delta height between the centre of the device and the aimed point.
	Device Ht	When measuring hidden points, the height of the hidden point measurement device can be typed in. This option should be used when the hidden point can be directly measured using the hidden point device.
	Device & Trgt Ht	When measuring hidden points, the height of the hidden point measurement device as well as the target height can be typed in. This option should be used when the hidden point cannot be directly measured with a hidden point device but a target point can be used to calculate the position of the hidden point.
<Device Ht:>	User input	The height of the hidden point measurement device. This is the distance from the ground to the centre of the device.
<Target Ht:>	User input	The distance from the hidden point to the aimed point.
<Dist Offset:>	User input	The offset is automatically added to the measured distance.
<EAO Method:>		Sets the default method for entering an External Angle Offset . EAO is an offset angle between the North of the device being used and WGS 1984 geodetic North. EAO's are applied when measuring hidden points using a device capable of measuring azimuths.
	None	No EAO value is applied to the azimuth measurement received from the hidden point measurement device.
	Permanent	Applies a default value for the offset angle. The value is changeable.
	New for Each Pt	Offset angle values must be entered for each new hidden point.
<Offset:>	User input	Available for <EAO Method: Permanent> . The default value for the offset angle.

Next step

Step	Description
1.	CONT (F1) returns to CONFIGURE Hidden Point Measurements .
2.	CONT (F1) returns to the screen from where CONFIGURE Hidden Point Measurements was accessed.

20.4 SmartAntenna

Description

The SmartAntenna interface is used to send the measurement data from the SmartAntenna to the RX1250.

The settings on this screen define the port and the device through which a connection to the SmartAntenna should be established.



The configuration of a SmartAntenna interface is only possible for RX1250.

Establish connection automatically

Automatic connection

Establishing a connection is initiated automatically upon switching on RX1250.

OR

double clicking the icon  on Windows CE desktop to display the Leica software.

Requirements

The SmartAntenna interface is configured such that SmartAntenna is being used via Bluetooth.

AND

An **<ID Address:>** is available.

AND

A SmartAntenna is found that matches **<ID Address:>** configured. This can be the last used **<ID address:>**.

If one of these requirements is not fulfilled, a search for a SmartAntenna is performed.

Access

Select **Main Menu: Config...Interfaces....** Highlight **SmartAntenna. EDIT (F3).**

CONFIGURE SmartAntenna Interface

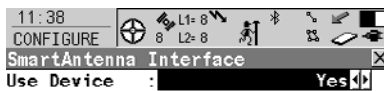

Port : Bluetooth 1
 Device : ATX1230
 ID Address : 80371d9b13



CONT (F1)

To accept changes and return to the screen from where this screen was accessed. To establish a connection to the SmartAntenna.

SRCH (F4)

Available for **<Use Device: Yes>**. To search for all available SmartAntenna's. If more than one SmartAntenna is found a list of available SmartAntenna's is provided.

DEVCE (F5)

Available for **<Use Device: Yes>**. To create, select, edit or delete a device.

Description of fields

Field	Option	Description
<Use Device:>	Yes or No	Activates the SmartAntenna interface.

Field	Option	Description
<Port:>	<p>Bluetooth x</p> <p>Port 1</p>	<p>Port to which the SmartAntenna will be connected.</p> <p>The Bluetooth port which will be used for the interface functionality. Enables cablefree communication between the SmartAntenna and the RX1250.</p> <p>LEMO port on RX1250. To be selected when RX1250 and SmartAntenna are connected via USB cable.</p>
<Device:>	<p>Output</p> <p><Bluetooth x></p>	<p>The device that is currently configured to <Port:>.</p> <p>The Bluetooth device inside the RX1250 that is currently configured to <Port:>.</p>
<ID Address:>	Output	The ID address of the SmartAntenna to be used.

Next step

CONT (F1) returns to the screen from where **CONFIGURE SmartAntenna Interface** was accessed. A connection to the SmartAntenna is established.

20.5 Internet

Description

The Internet interface

- allows accessing the Internet using a GPS1200 receiver plus a GPRS or CDMA device.
- can be used together with the Real-Time interface to receive real-time data from a NTRIP Caster via Internet communication.

Access

Select **Main Menu: Config...Interfaces...** Highlight Internet. **EDIT (F3)**.

CONFIGURE

Internet Interface

12:09
 CONFIGURE
 Internet Interface
 Internet : Yes
 Port : Port 1
 Device : Siemens MC45
 IP Address: Dynamic
 Set IP Adr: 192.168.1.3
 User ID : 123
 (cont) : -----
 CONT DEVCE

CONT (F1)

To accept changes and return to the screen from where this screen was accessed.

DEVCE (F5)

To create, select, edit or delete a device.

Description of fields

Field	Option	Description
<Internet:>	Yes or No	Activates the Internet interface.
<Port:>	Bluetooth x	Available for RX1250. The Bluetooth port which will be used for the interface functionality.
	Port x	The physical port P1, P2 or P3 on the instrument to which the device is attached.
	Port 1	Available for RX1250. LEMO port on RX1250.
<IP Address:>	Dynamic	Each time a GPS1200 receiver wants to access the Internet via the device a new IP address is assigned to the receiver. When using GPRS to connect to the Internet then the network provider always dynamically assigns the IP address.
	Static	Each time GPS1200 wants to access the Internet via the device the same IP address identifies the receiver. This is important if GPS1200 is used as a TCP/IP server. This option should only be selected if a static IP address is available for the receiver.
<Set IP Adr:>	User input	Available for <IP Address: Static>. To set the IP address.

Field	Option	Description
<User ID:>	User input	Some providers ask for a user ID to allow connecting to the Internet via GPRS or CDMA. Contact your provider if a user ID needs to be used.
<(cont):>	User input	Allows the <User ID:> string to continue onto a new line.
<Password:>	User input	Some providers ask for a password to allow connecting to the Internet via GPRS or CDMA. Contact your provider if a password is required.

Next step

CONT (F1) returns to the screen from where **CONFIGURE Internet Interface** was accessed.

21 Configuration of Devices

21.1 Overview

Description

A device is the hardware which is connected to a chosen port of GPS1200. Devices are used to transmit and receive real-time data and to communicate with the receiver.

Before using any device it is necessary to configure the interface with which it will be used. Some devices may be used with different interfaces for different applications. For example, a radio can be used to receive real-time reference data but a second radio could also be used to simultaneously output NMEA messages.

21.2 Accessing CONFIGURE Devices / GPRS Internet Devices

Description

Allows devices to be created, edited, selected and deleted. Refer to "22 Config...\Interfaces... - Controlling Devices" for more information about configuring devices.

Access step-by-step

Step	Description
1.	Main Menu: Config...\Interfaces...
2.	Highlight the appropriate interface based on the type of device that needs to be configured. For example, highlight Real-Time when a radio is to be configured.
3.	EDIT (F3) to access CONFIGURE XX .
4.	DEVICE (F5) to access CONFIGURE Devices / CONFIGURE GPRS Internet Devices .

CONFIGURE Devices; CONFIGURE GPRS Internet Devices

This screen may consist of several pages and provides different devices for selection depending on which interface the screen was accessed from. The functionality described below is always the same.

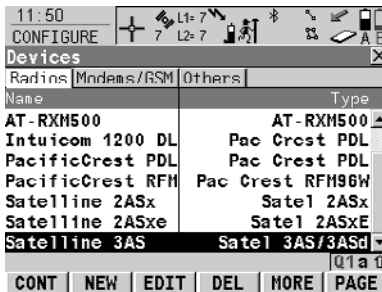

CONT (F1)

To select the highlighted device and return to the screen from where this screen was accessed.

NEW (F2)

To create a new device.

EDIT (F3)

To edit the highlighted device.

DEL (F4)

To delete the highlighted device.

MORE (F5)

To display information about the type of device and the creator of the device.

SHIFT DEFLT (F5)

To recall previously deleted default devices and to reset default devices to the default settings.

Description of columns

Column	Description
Name	Names of available devices.
Type	Type of device defined when creating the device.
Creator	The creator of the device. The creator can either be Default if the device is a default, or User if the device has been created.  If a Default device is edited by using EDIT (F3) then its creator is still displayed as Default .

Next step

CONT (F1) closes the screen and returns to the screen from where **CONFIGURE Devices / CONFIGURE GPRS Internet Devices** was accessed.

21.3 Creating a New Device / Editing a Device

Access step-by-step

Step	Description
1.	Refer to "21.2 Accessing CONFIGURE Devices / GPRS Internet Devices" to access CONFIGURE Devices / CONFIGURE GPRS Internet Devices .
2.	In CONFIGURE Devices / CONFIGURE GPRS Internet Devices highlight a device of the same type as the device to be created, from the list.
3.	NEW (F2)/EDIT (F3) to access CONFIGURE New Device/CONFIGURE Edit Device .



Editing a device is similar to creating a new device. For simplicity, the screens are called **CONFIGURE XX Device** and differences are clearly outlined.

CONFIGURE XX Device

11:53
 CONFIGURE
 New Device

Name : **New Radio**
 Type : **Sate1 3AS/3ASd**
 Baud Rate : **9600**
 Parity : **None**
 Data Bits : **8**
 Stop Bit : **1**
 Flow Control : **RTS/CTS**

STORE

STORE (F1)

To store the new device and b return to the screen from where this screen was accessed.

ATCMD (F4)

Available for digital cellular phones and modems. To configure communication commands.

Description of fields

Field	Option	Description
<Name:>	User input Output	Available when creating a new device. Name of new device. Available when editing a device. The name of the device.
<Type:>	Output	The type of device.
<GRPS/Internet:>	Yes or No	Available for digital cellular phones and modems. Defines the device as an Internet capable device and adds it to the list in CONFIGURE GPRS Internet Devices .
<Baud Rate:>	From 2400 to 115200	Frequency of data transfer from receiver to device in bits per second.
<Parity:>	None , Even or Odd	Error checksum at the end of a block of digital data.
<Terminator:>	CR/LF	Available when editing a device and if required by the interface. The terminator is a carriage return followed by a line feed.

Field	Option	Description
	CR	Not available for RS232 device. The terminator is a carriage return.
<Data Bits:>	6, 7 or 8	Number of bits in a block of digital data.
<Stop Bits:>	1 or 2	Number of bits at the end of a block of digital data.
<Flow Control:>	None or RTS/CTS	Activates hardware handshake.

Next step

IF the device is a	THEN
radio or device other than digital cellular phone or modem	STORE (F1) to close the screen and to return to the screen from where CONFIGURE XX Device was accessed.
digital cellular phone or modem	ATCMD (F4) . Refer to paragraph "CONFIGURE GSM/Modem AT Command Lines".

CONFIGURE GSM/Modem AT Command Lines

For **<GPRS/Internet: Yes>** in **CONFIGURE XX Device**, this screen consists of two pages. The following table lists the fields of both pages.

Description of fields

Field	Option	Description
<Init 1:>	User input	Initialisation sequence to initialise digital cellular phone/modem.
<(cont):>	User input	Allows the <Init X:> or the <Connect:> string to continue onto a new line.
<Init 2:>	User input	Initialisation sequence to initialise digital cellular phone/modem.
<Dial:>	User input	Dialing string used to dial the phone number.
<Hangup:>	User input	Hangup sequence used to end the network connection.
<Escape:>	User input	Escape sequence used to switch to the command mode before using the hangup sequence.
<Connect:>	User input	Dialing string used to dial into the Internet.

When the device is used, between **<Init 1:>** and **<Init 2:>**, a check for the PIN is performed.

Next step

Step	Description
1.	STORE (F1) returns to CONFIGURE XX Device .

Step	Description
2.	STORE (F1) returns to the screen from where CONFIGURE XX Device was accessed.

22.1 Accessing Config...\Interfaces... - Controlling Devices

Access step-by-step

Step	Description
1.	Main Menu: Config...\Interfaces... to access CONFIGURE Interfaces .
2.	In CONFIGURE Interfaces highlight an interface which has the device attached that needs to be configured.
3.	CTRL (F4) to access CONFIGURE XX Connection/CONFIGURE Radio Channel .

22.2 Digital Cellular Phones

Description

For digital cellular phones, information such as

- the reference stations that can be contacted
- the phone numbers of the reference stations and
- the type of protocol to be used

can be defined.

Access

Refer to "22.1 Accessing Config...\Interfaces... - Controlling Devices" to access **CONFIGURE XX Connection**.

CONFIGURE XX Connection

The name of the screen depends on the type of technology of the digital cellular phone chosen in **CONFIGURE Interfaces**.

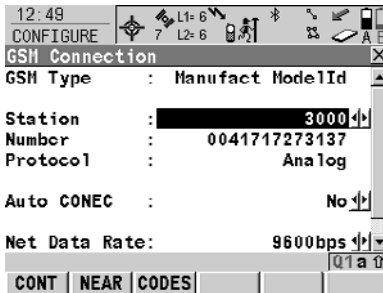

CONT (F1)

To accept the change and to continue with the subsequent screen.

NEAR (F2)

Available when reference stations to dial are already created in **CONFIGURE Stations to Dial**. To find the nearest reference station with a digital cellular phone.

CODES (F3)

Available for digital cellular phones of GSM technology. To enter the **Personal Identification Number** of the SIM card.

SRCH (F4)

Available for **<Bluetooth: Yes>**. To search for all available Bluetooth devices.

SHIFT INFO (F2)

Available for CDMA digital cellular phones. To find out information about the digital cellular phone. All information can be printed to a file CDMA Info.log in the \DATA directory on the CompactFlash card.

SHIFT REG (F3)

Available for CDMA digital cellular phones. To register the digital cellular phone.

SHIFT CMND (F4)

To send AT commands to the digital cellular phone.

Description of fields

Field	Option	Description
<GSM Type:>	Output	Available for digital cellular phones of GSM technology. The type of digital cellular phone highlighted when CONFIGURE XX Connection was accessed.
<CDMA Type:>	Output	Available for digital cellular phones of CDMA technology. The type of digital cellular phone highlighted when CONFIGURE XX Connection was accessed.
<Bluetooth:>	Yes or No	GPS1200 receivers detect automatically if the attached device is bluetooth capable. Some devices ask for the identification number of the Bluetooth. The identification number of Leica's Bluetooth is 0000. The field is unavailable for RX1250 with SmartAntenna.
<ID Address:>	User input	Available for <Bluetooth: Yes>. The ID address of the Bluetooth device to be used. Refer to the device's user manual for information about the ID address.
<Station:>	Choicelist	The digital cellular phone reference station to be dialed. Opening the choicelist accesses CONFIGURE Stations to Dial where new reference stations can be created and existing reference stations can be selected or edited.
<Number:>	Output	The number of the digital cellular phone at the selected <Station:> as configured in CONFIGURE Stations to Dial .
<Protocol:>	Output	Available for digital cellular phones of GSM technology. The configured protocol of the digital cellular phone at the selected <Station:> as configured in CONFIGURE Stations to Dial .
<Auto CONEC:>	Yes or No	Allows for automatic connection between the rover and the reference when a point is occupied during a survey.
<Net Data Rate:>	Autobauding, 2400 bps to 56000 bps	Available for digital cellular phones of GSM technology. The network baud rate. Select Autobauding for an automatic search of the network baud rate. For digital cellular phones of GSM technology that do not support autobauding choose the baud rate from the choicelist.
<Connection:>	Transparent	Available for digital cellular phones of GSM technology. Define if the digital cellular phone uses Radio Link Protocol . For digital cellular phones that do not use RLP.

Field	Option	Description
	Non-Transparent	For digital cellular phones that use RLP.

Next step

IF the digital cellular phone is	THEN
not of type CDMA or does not need to be registered	CONT (F1) to accept the change and to continue with the subsequent screen.
of type CDMA and needs registering	SHIFT REG (F3) to access CONFIGURE CDMA Registration . Refer to paragraph "CONFIGURE CDMA Registration".

CONFIGURE CDMA Registration

Description of fields

Field	Option	Description
<Prog Code:>	User input	The service program coder provided by the network provider.
<My Phone No:>	User input	Type in the mobile directory number provided by the network provider.

Next step

Step	Description
1.	CONT (F1) returns to CONFIGURE Interfaces .
2.	CONT (F1) returns to the screen from where CONFIGURE Interfaces was accessed.

22.3 Radios

Description

For radios the channels on which the radio broadcasts can be changed. Changing channels changes the frequency at which the radio operates.

Access

Refer to "22.1 Accessing Config...\Interfaces... - Controlling Devices" to access **CONFIGURE Radio Channel**.



Channel changing may contravene radio broadcasting regulations in certain countries. Before operating with radios, check the regulations in force in the working area.



If channel changing is to be used, when configuring the reference real-time interface, set **<Ref Stn ID:>** in **CONFIGURE Additional Reference Options, General** page to a different ID for each reference site. By doing so, the rover can recognise if the incoming real-time data after channel changing is being received from a different reference station or if the original reference station is using a new frequency. In the first case, the ambiguities are recomputed.

CONFIGURE Radio Channel

Radio Type : Satellite 3AS
 Channel : 10
 Actual Freq : 433.525 MHz

CONT (F1)

To accept the changes and to continue with the subsequent screen.

SCAN (F5)

To find out information such as the station ID, latency and the data format of incoming signals from reference stations.

CONT SCAN

Description of fields

Field	Option	Description
<Radio Type:>	Output	The type of radio highlighted when CONFIGURE Radio Channel was accessed.
<Channel:>	User input	The radio channel. The minimum and maximum allowed input values for a radio depend on the number of channels supported by the radio and the spacing between the channels.
<Actual Freq:>	Output	Available for <Radio Type: Satellite 3AS> . Displays the actual frequency of the radio.

22.4 Hidden Point Measurement Devices

Description

Hidden point measurement devices can be used to measure distances, angles and azimuths to points which are not accessible by means of GPS. A Bluetooth housing can be used to provide a wireless connection between the receiver and a Bluetooth enabled hidden point measurement device.

Access

Refer to "22.1 Accessing Config...\Interfaces... - Controlling Devices" to access **CONFIGURE RS232 Connection**.

CONFIGURE RS232 Connection

11:40
CONFIGURE
RS232 Connection

Device : RS232

Bluetooth : Yes

ID Address : [REDACTED]

CONT (F1)

To accept the changes and to continue with the subsequent screen.

SRCH (F4)

Available for **<Bluetooth: Yes>**. To search for all available Bluetooth devices.

CONT SRCH Q1 a

Description of fields

Field	Option	Description
<Type:>	Output	The type of hidden point measurement device highlighted when CONFIGURE RS232 Connection was accessed.
<Bluetooth:>	Output	GPS1200 receivers detect automatically if the attached devices is bluetooth capable. Some devices ask for the identification number of the Bluetooth. The identification number of Leica's Bluetooth is 0000. The field is unavailable for RX1250 with SmartAntenna.
<ID Address:>	User input	Available for <Bluetooth: Yes> . The ID address of the Bluetooth device to be used. Refer to the device's user manual for information about the ID address.

22.5 GPRS / Internet Devices

Description

GPRS / Internet devices can be used to access the Internet from a GPS1200 receiver.

Access

Refer to "22.1 Accessing Config...\Interfaces... - Controlling Devices" to access **CONFIGURE GPRS/Internet Connection**.

CONFIGURE GPRS/Internet Connection

11:39
 CONFIGURE
 GPRS/Internet Connection
 Device : Manufact ModelId
 APN :
 (cont) :
 CONT CODES

CONT (F1)

To accept the changes and to continue with the subsequent screen.

CODES (F3)

Available for digital cellular phones of GSM technology. To enter the **Personal Identification Number** of the SIM card. If the PIN is locked for any reason, input the **Personal Unblock**ing code for access to the PIN.

SRCH (F4)

Available for **<Bluetooth: Yes>**. To search for all available Bluetooth devices.

SHIFT CMND (F4)

To send AT commands to the GPRS / Internet device.

Description of fields

Field	Option	Description
<Device:>	Output	The type of GPRS / Internet device highlighted when CONFIGURE GPRS/Internet Connection was accessed.
<Bluetooth:>	Output	GPS1200 receivers detect automatically if the attached device is bluetooth capable. Some devices ask for the identification number of the Bluetooth. The field is unavailable for RX1250 with SmartAntenna.
<ID Address:>	User input	Available for <Bluetooth: Yes> . The ID address of the Bluetooth device to be used. Refer to the device's user manual for information about the ID address.
<APN:>	User input	Available for some GPRS / Internet devices. The Access Point Name of a server from the network provider, which allows access to data services. Contact your provider to get the correct APN. Mandatory for using GPRS.

22.6 Creating a New Station to Dial/Editing a Station to Dial

Description

CONFIGURE Stations to Dial allows new stations to be created, provides a list of reference stations that can be dialed and allows existing stations to be edited. For digital cellular phones of any technology and for modems, the phone numbers of the device at the reference station must be known. For a reference station to be dialed, a name, the phone number and, if available, the coordinates can be configured.

The configuration is possible for rover and reference digital cellular phones and modems.

Access step-by-step

Step	Description
1.	Refer to "22.1 Accessing Config...Interfaces... - Controlling Devices" to access CONFIGURE XX Connection/CONFIGURE Radio Channel .
2.	Open the choicelist for <Station:> to access CONFIGURE Stations to Dial .
3.	CONFIGURE Station to Dial If a station is to be edited, then highlight the station.
4.	NEW (F2)/EDIT (F3) to access CONFIGURE New Station to Dial/CONFIGURE Edit Station to Dial .



Editing a station to dial is similar to creating a new station to dial. For simplicity the screens are called **CONFIGURE XX Station to Dial** and differences are clearly outlined.

CONFIGURE XX Station to Dial

12:04
CONFIGURE
New Station to Dial

Name : 3000

Number : 0041717273137

Protocol : Ana log

Enter Coords : Yes

WGS84 X : 4264320.8341 m

WGS84 Y : 725157.3550 m

WGS84 Z : 4672132.0505 m

STORE | COORD

STORE (F1)

To store the charges and to continue with the subsequent screen.

COORD (F2)

To view other coordinate types.

SHIFT ELL H (F2) or SHIFT ORTH (F2)

Available for local coordinates. To change between the ellipsoidal and the orthometric height.

Description of fields

Field	Option	Description
<Name:>	User input	A unique name for the new reference station to be dialed. The name may be up to 16 characters long and may include spaces. Input optional.

Field	Option	Description
<Number:>	User input	The number of the reference station to dial. If the survey is to be undertaken across country borders it is necessary to input the phone number using standard international dialing codes. For example, +41123456789. Otherwise it can be input as a standard digital cellular phone number.
<Protocol:>	Analog ISDN v. 110	Available for digital cellular phones of GSM technology. The configured protocol of the digital cellular phone of GSM technology. For conventional phone networks. For GSM networks.
<Enter Coords:>	Yes or No	Allows the coordinates of the reference station to be entered.
Coordinates	User input	The coordinate of the reference station.

Next step

Step	Description
1.	STORE (F1) stores the changes and returns to CONFIGURE Stations to Dial .
2.	CONT (F1) returns to the screen from where CONFIGURE Stations to Dial was accessed.

22.7 Creating a New Server to Connect/Editing a Server to Connect

Description

CONFIGURE Server to Connect allows new servers to be created, provides a list of servers to be connect in the internet and allows existing servers to be edited. For servers to be accessed in the Internet the IP address and the TCP/IP port must be known. For a server to be accessed in the Internet a name can be configured.

Access step-by-step

Step	Description
1.	Refer to "22.1 Accessing Config...Interfaces... - Controlling Devices" to access CONFIGURE XX Connection/CONFIGURE Radio Channel .
2.	Open the choicelist for <Server:> to access CONFIGURE Server to Connect .
3.	CONFIGURE Server to Connect If a server is to be edited, then highlight the server.
4.	NEW (F2)/EDIT (F3) to access CONFIGURE New Server to Connect/CONFIGURE Edit Server to Connect .



Editing a server to connect is similar to creating a new server to connect. For simplicity the screens are called **CONFIGURE XX Server to Connect** and differences are clearly outlined.

CONFIGURE XX Server to Connect

17:12 CONFIGURE

New Server

Name :

IP Address : 192.168.1.1

TCP/IP Port : 80

STORE (F1)

To store the changes and to continue with the subsequent screen.

STORE

Description of fields

Field	Option	Description
<Name:>	User input	A unique name for the new server to be accessed in the Internet. The name may be up to 16 characters long and may include spaces.
<IP Address:>	User input	The IP address of the server to be accessed in the Internet.
<TCP/IP Port:>	User input	The port of the Internet server through which the data is provided. Each server has several ports for various services.

Next step

Step	Description
1.	STORE (F1) stores the changes and returns to CONFIGURE Server to Connect .
2.	CONT (F1) returns to the screen from where CONFIGURE Server to Connect was accessed.

23.1 Format Memory Device

Description Allows the CompactFlash card, the internal memory, if fitted, and the System RAM to be formatted. All data will be erased.

Access Select **Main Menu: Tools...Format Memory Device.**

Way of working step-by-step

Step	Description
1.	Select the memory device to be formatted.
2.	Select the type of format to be performed.  A quick format means that after formatting, data is not visible any more but still exists on the memory device and is overwritten as and when required. A complete format fully deletes the data.

Next step

IF	THEN
the CompactFlash card or internal memory is to be formatted	CONT (F1) to format the selected memory device and return to GPS1200 Main Menu.
the application programs memory is to be formatted	PROGS (F4) to format the application programs memory. All loadable application programs are deleted.
the System RAM is to be formatted	SYSTM (F5) to format the System RAM.



If the System RAM is formatted all system data such as almanac, user defined configuration sets, user defined antennas, codelists, geoid field files and CSCS field files will be lost.

23.2 Transfer Objects...

Description

This chapter describes the basic procedure for transferring objects between the CompactFlash card, and the internal memory, if fitted, and the System RAM.

Access

Select **Main Menu: Tools... \Transfer Objects... \XX**.

Way of working step-by-step

Step	Description
	The available fields on the screen depend on the option selected in Main Menu: Tools... \Transfer Objects...
1.	Select the memory device to transfer the object from.
2.	Select the memory device to transfer the object to.
3.	Select the object to transfer.

Next step

IF all XX	THEN
are to be transferred	ALL (F3) transfers all objects in list.
are not to be transferred	CONT (F1) transfers selected object.

23.3 Upload System Files...

Description

System file uploads are possible from the CompactFlash card to a particular memory device, depending on the type of file chosen to be uploaded. These files are stored in the \SYSTEM directory of the memory device.



SmartAntenna must always be connected to RX1250 when uploading the firmware. Connect SmartAntenna and RX1250 via cable. Uploading the firmware takes some time.

Access

Select **Main Menu: Tools...Upload System Files...XX**.

Way of working step-by-step

Step	Description
1.	Select the memory device to upload the system file from.
2.	Select the memory device to upload the system file to.
3.	Select the system file to upload.

Next step

CONT (F1) uploads the selected system file.

23.4 Calculator and File Viewer



Refer to GPS1200 Technical Reference Manual for information on these functionalities.

23.5 Licence Keys

Description

A licence key can be used to activate application programs and protected options and can be used to define the expiry date of the software maintenance. A licence key file can be uploaded to the receiver/RX1250. To upload a licence key file the file should be located on the \SYSTEM directory of the CompactFlash card. Licence key files use the naming convention L_123456.key, where 123456 is the instrument serial number. Licence keys can also be typed in manually in **Main Menu: Tools...Licence Keys** or the first time the application program is started.

Access

Select **Main Menu: Tools...Licence Keys**.
OR
Select an application program not yet activated.

Way of working step-by-step

Step	Description
1.	Select the method by which the licence key will be input.
2.	Depending on the method chosen the licence key can be typed in.

Next step

CONT (F1) returns to **GPS1200 Main Menu** or continues with selected application program.

24 STATUS

24.1 STATUS: Survey...

24.1.1 Satellite Status

Description

This screen shows information related to the satellites ordered by the elevation angle.

Access

Step	Description
1.	Press USER to access GPS1200 User Menu .
2.	Press STAT (F3) to access STATUS Status Menu .
3.	Select Survey...Satellite Status .

STATUS Satellites,
Satellites page;
STATUS Satellites,
Rover page

The name of the page changes depending on the active receiver configuration.

The information about the satellites at the reference shown on the **Reference** page is identical with the information shown on **STATUS Satellites, Rover** page

The screenshot shows the STATUS Satellites screen. At the top, the time is 17:47 and the screen title is STATUS. Below the title is a 'Satellites' window with a close button. The main table has columns: Rvr, SkypInt, Reference, Sat, Elev, Azimuth, S/N 1, and S/N 2. The data rows are as follows:

Rvr	SkypInt	Reference	Sat	Elev	Azimuth	S/N 1	S/N 2
			G13	↑ 80	260	50	42
			R1	↓ 71	47	48	36
			G23	↓ 60	56	50	41
			G4	↑ 56	280	50	40
			G24	↓ 55	193	50	40
			R2	↑ 39	310	45	34
			G20	↓ 30	105	47	33

At the bottom of the screen is a menu with the following options: CONT, GPS X, GLO X, HELTH, MORE, and PAGE.

CONT (F1)

To exit **STATUS Satellites**.

GPS X / GPS ✓ (F2)

To hide or show the GPS satellites (shown by the prefix G). Available for GX1230 GG/ATX1230 GG when **<Sat System: GPS & Glonass>** is configured in **CONFIGURE Satellite Settings**.

GLO X / GLO ✓ (F3)

To hide or show the GLONASS satellites (shown by the prefix R). Available for GX1230 GG/ATX1230 GG when **<Sat System: GPS & Glonass>** is configured in **CONFIGURE Satellite Settings**.

HELTH (F4)

To view the numbers of satellites categorised in good, bad and unavailable.

MORE (F5)

To open and close a window showing the date of the used almanac, the number of satellites tracked as shown on the skyplot and the number of all satellites available above the cut off elevation mask as shown on the skyplot.

Description of columns

Column	Description
Sat	The Pseudo Random Noise number (GPS) or the slot number (GLONASS) of the satellites.
Elev	The elevation angle in degrees. The arrow indicates if a satellite is rising or falling.
Azmth	The azimuth of the satellite.
S/N 1 and S/N 2	The signal to noise ratio on L1 and L2. The number is shown in brackets if the signal is currently not being used in the position calculations.

Next step

PAGE (F6) changes to the **Skyplot** page.

STATUS Satellites, Skyplot page

The skyplot shows satellite information in a graphical way. Satellites below the **<Cut Off Angle:>** configured in **CONFIGURE Satellite Settings** are marked grey. The part of the skyplot between the 0° elevation and the cut-off angle is marked grey.

Description of symbols

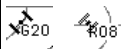
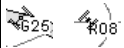
Symbol	Description
	Satellites above the <Cut Off Angle:> configured in CONFIGURE Satellite Settings .
	Satellites below the <Cut Off Angle:> configured in CONFIGURE Satellite Settings .

Next step

CONT (F1) exits **STATUS Satellites**.

24.1.2 Real-Time Status

Description

This screen shows information related to real-time data. The name of the screen changes depending on the configuration:

Real-time rover configuration: **STATUS Real-Time Input**
 Real-time reference configuration with one real-time device: **STATUS Real-Time Output**
 Real-time reference configuration with two real-time devices: **STATUS Real-Time Output 1 and STATUS Real-Time Output 2**

For simplicity, the screen is named here as **STATUS Real-Time**. Differences depending on the configurations are outlined.

Access

Step	Description
1.	Press USER to access GPS1200 User Menu .
2.	Press STAT (F3) to access STATUS Status Menu .
3.	Select Survey...Real-Time Status .

STATUS Real-Time, General page

The screenshot shows the STATUS Real-Time Input screen with the following data:

Field	Value
R-Time Data	Leica
GPS Used L1/L2	07/07
GLO Used L1/L2	03/03
RTK Data Link Messages	
Last Received	1.0 sec
In Last Minute	100 %
Ref Network	None

At the bottom of the screen, there are navigation buttons: **CONT**, **DATA**, and **PAGE** (with an up arrow icon).

CONT (F1)

To exit **STATUS Real-Time**.

DATA (F4)

To view the data being received. Depending on **<R-Time Data:>**, the shown data differ.

REF2 (F5) and REF1 (F5)

Available for **<R-Time Mode: Reference>** with two real-time devices configured. To change between the status information for both real-time devices.

Description of fields

Field	Description
<R-Time Data:>	The received real-time data format message type.
<GPS used L1/L2:>	The number of satellites on L1 and L2 being used in the current position solution.
<GLO used L1/L2:>	Available for GX1230 GG/ATX1230 GG/GRX1200 GG Pro when <Sat System: GPS & GLONASS> is configured in CONFIGURE Satellite settings . The number of satellites on L1 and L2 being used in the current position solution.
<Last Sent:>	Available for <R-Time Mode: Reference> . Seconds since the last message from the reference was sent.
<Last Received:>	Available for <R-Time Mode: Rover> . Seconds since the last message from the reference was received.

Field	Description
<In Last Minute:>	Available for <R-Time Mode: Rover>. The percentage of real-time data received from the reference compared with the data received from the GNSS antenna within the last minute. This indicates how well the datalink is working.
<Ref Network:>	Available for <R-Time Mode: Rover>. The type of reference network in use.
<Output NMEA:>	Available for <R-Time Mode: Rover> unless <Ref Network: None>. The type of NMEA message sent to the reference network. If more than one message is sent at a time, then all types are shown separated by comma.

Next step

PAGE (F6) changes to the **Device** page.

The content of this page differs for each type of device in use.

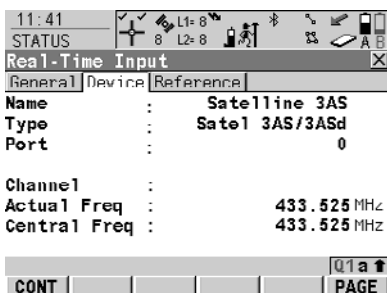

CONT (F1)

To exit **STATUS Real-Time**.

ACCNT (F3)

Available for Smartgate device. To view Smartgate account information.

VERS (F4)

Available for Smartgate device. To view Smartgate version information.

For all devices available

Description of fields

Field	Description
<Name:>	The name of the device.

For digital cellular phones and modems

Description of fields

Field	Description
<Type:>	The type of device.
<Port:>	The port to which the device is connected.
<Firmware:>	The software version of the attached digital cellular phone.
<Operator:>	The name of the network operator in which the digital cellular phone is operating.
<Status:>	The actual mode of the digital cellular phone. The options are Unknown , Searching and Registered .

Field	Description
<Bluetooth:>	Available if device is connected via bluetooth. Indicates the state of the connection.
<Signal:>	Indication of received signal strength of the digital cellular phone network.

For Satellite 3AS radios

Description of fields

Field	Description
<Port:>	The port to which the device is connected.
<Type:>	The type of device.
<Channel:>	The radio channel.
<Actual Freq:>	The actual set frequency of the radio.
<Central Freq:>	The defined central frequency of the radio.
<Firmware:>	The software version of the attached radio.

For Pacific Crest PDL radios

Description of fields

Field	Description
<Port:>	The port to which the device is connected.
<Type:>	The type of device.
<Channel:>	The radio channel.

Next step

PAGE (F6) changes to the **Reference** page.

STATUS Real-Time, Reference page

As shown below, the name of the page changes depending on the type of reference being used.

Name of page	Description
Reference page	Reference is a real reference station.
Ref (Nearest) page	Reference is the closest to the rover determined by for example LEICA GPS Spider.
Ref (i-MAX) page	Reference information are individualised Master-Auxiliary corrections determined and sent by for example LEICA GPS Spider.
Ref (MAX) page	Reference information are Master-Auxiliary corrections determined and sent by for example LEICA GPS Spider.
Ref (VRS) page	Reference is a virtual reference station.
Ref (FKP) page	Reference information are area correction parameters.

Description of fields

Field	Description
<Ref Stn ID:>	An identification for a reference station. The ID can be converted into a compact format to be send out with real-time data in all real-time data formats. It is different from the point ID of the reference station.
<Antenna Ht:>	<ul style="list-style-type: none"> For <R-Time Data: Leica>, <R-Time Data: RTCM v3.0> or <R-Time Data: RTCM X v2> with <RTCM Version: 2.3>: The antenna height at the reference from the marker to the MRP. For <R-Time Data: CMR/CMR+> and <R-Time Data: RTCM 18, 19 v2> or <R-Time Data: RTCM 18, 19 v2> with <RTCM Version: 2.2> The antenna height at the reference from the marker to the phase center. For all other <R-Time Data:>: ----- is displayed because the data format does not include information about the antenna height.
<Coords of:>	<p>The coordinates for the reference station which are transferred depend on the active real-time data format.</p> <ul style="list-style-type: none"> For real-time messages which include antenna height and antenna type: Marker.
	<ul style="list-style-type: none"> For real-time messages which do not include antenna information: Phase Centre of L1.
<No.of Aux Ref:>	The number of active auxiliary reference stations from which data is received.

Next step

CONT (F1) exits **STATUS Real-Time**.

STATUS Real-Time Input Data

The following provides additional information on the satellite data received via real-time message. Information of those satellites is displayed, which are used on both reference and rover.

Access

DATA (F4) on **STATUS Real-Time, General** page.

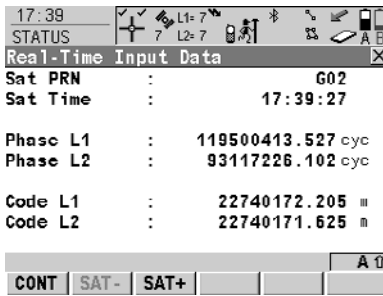

CONT (F1)

To return to **STATUS Real-Time**.

SAT- (F2)

To display information about the satellite with the next smaller PRN.

SAT+ (F3)

To display information about the satellite with the next larger PRN.

Description of fields

The data being received from the satellites and the layout of the screen depend on the active real-time data format.

Field	Description
<Sat PRN:>	The PRN number (GPS) or the slot number (GLONASS) of the satellites shown with the prefix G (GPS) or R (GLONASS).
<Sat Time:>	The GPS time of the satellite.
<Phase L1:>, <Phase L2:>	The number of phase cycles from the antenna to the satellite on L1 and L2.
<Msg 18 L1:>, <Msg 18 L2:>	The uncorrected carrier phases for L1 and L2.
<Msg 20 L1:>, <Msg 20 L2:>	The carrier phase corrections for L1 and L2.
<Code L1:>, <Code L2:>	The pseudorange between the antenna to the satellite for L1 and L2.
<Msg 19 L1:>, <Msg 19 L2:>	The uncorrected pseudoranges for L1 and L2.
<Msg 21 L1:>, <Msg 21 L2:>	The pseudorange corrections for L1 and L2.
<PRC:>	Pseudorange corrections.
<RRC:>	Rate of change of the corrections.
<IODE:>	Issue Of Data Ephemeris. The identification number of the ephemeris for a satellite.

Next step

CONT (F1) returns to the screen from where **STATUS Real-Time Input Data** was accessed.

24.1.3 Current Position

Description

This screen shows information related to the current antenna position and the speed of the antenna. For real-time rover configurations the baseline vector is also shown. MapView shows the current position in a graphical way.

Access

Step	Description
1.	Press USER to access GPS1200 User Menu .
2.	Press STAT (F3) to access STATUS Status Menu .
3.	Select Survey... \Current Position .

STATUS Position, Position page

Field	Description
Local Time	11:42:43.0
Pos Latency	0.00 sec
WGS84 Lat	47°24'32.25457" N
WGS84 Long	9°37'02.87266" E
WGS84 Ell Ht	482.224 m
Pos Quality	0.005 m
Ht Quality	0.009 m

Navigation buttons: **CONT**, **COORD**, **PAGE**

CONT (F1)

To exit **STATUS Position**.

COORD (F2)

To see other coordinate types. Local coordinates are available when a local coordinate system is active.

SHIFT ELL H (F2) and SHIFT ORTH (F2)

Available for local coordinates. To change between the ellipsoidal and the orthometric height.

Description of fields

Field	Description
<Pos Latency:>	The latency of the computed position. Latency is mainly due to time required for data transfer and computation of position. Depends on the use of the prediction mode.
Pos Quality and Ht Quality	Available for phase fixed and code only solutions. The 2D coordinate and height quality of the computed position.
HDOP and VDOP	Available for navigated solutions.

Next step

PAGE (F6) changes to the **Baseline** or **Speed** page.

STATUS Position, Baseline page

Information on the baseline vector is displayed.

Next step

PAGE (F6) changes to the **Speed** page.

STATUS
Position,
Speed page

Description of fields

Field	Description
<Horizontal:>	The speed over ground in the horizontal direction.
<On Bearing:>	Available for local coordinate systems. The bearing for the horizontal direction related to the North direction of the active coordinate system.
<Vertical:>	The vertical component of the actual velocity.

Next step

PAGE (F6) changes to the **Map** page.

STATUS
Position,
Map page

The **Map** page provides an interactive display of the data.

Next step

CONT (F1) exits **STATUS Position**.

24.1.4 Logging Status

Description This screen shows information related to logging of raw observations, including ring buffer.

Access

Step	Description
1.	Press USER to GPS1200 User Menu .
2.	Press STAT (F3) to access STATUS Status Menu .
3.	Select Survey...Logging Status .

**STATUS
Logging,
General page**

General	Reference
Logging Raw Obs :	YES
Interval Type :	Static
Obs in Interval :	32
All Static Obs :	32
All Moving Obs :	0
Recorded DB-X Pts:	3

CONT					Q1a ↑
					PAGE

CONT (F1)

To exit **STATUS Logging**.

Description of fields

Field	Description
<All Static Obs:>	The number of static epochs recorded in the current job.
<All Moving Obs:>	The number of moving epochs recorded in the current job.
<Recorded DB-X Pts:>	The number of manually occupied points and auto points stored in the job.

Next step

IF	AND	THEN
at least one ring buffer is activated	-	PAGE (F6) changes to the Ring Buffer page. Refer to paragraph "STATUS Logging, Ring Buffer page".
no ring buffer is activated	the receiver is a real-time rover	PAGE (F6) changes to the Reference page or Ref (VRS) page. Refer to paragraph "STATUS Logging, Reference page".
no ring buffer is activated	the receiver is not a real-time rover	CONT (F1) exits STATUS Logging .

STATUS
Logging,
Ring Buffer page

Description of fields

Field	Description
<Ring Buffer No.:>	The number of the active ring buffer.
<No. of Files:>	The number of files stored in the ring buffer.
<Obs Flagged:>	The flag assigned to the stored observations.
<Obs Rate:>	The configured observation rate by which data is logged.
<First Obs at:>	The local time when the first observation available in the ring buffer is stored.
<Last Obs at:>	The local time when the last observation available in the ring buffer is stored.

Next step

PAGE (F6) changes to the **Reference** page, **Ref (FKP)** or **Ref (VRS)** page.

STATUS
Logging,
Reference page

As shown below, the name of the page changes depending on the type of reference used.

Name of page	Description
Reference page	Reference is a real reference station.
Ref (Nearest) page	Reference is the closest to the rover determined by for example LEICA GPS Spider.
Ref (i-MAX) page	Reference information are individualised Master-Auxiliary corrections determined and sent by for example LEICA GPS Spider.
Ref (MAX) page	Reference information are Master-Auxiliary corrections determined and sent by for example LEICA GPS Spider.
Ref (VRS) page	Reference is a virtual reference station.
Ref (FKP) page	Reference information are area correction parameters.

Description of fields

Field	Option	Description
<Log Static Obs:>	A time in sec	The logging rate at the reference. This information is shown if the real-time message format supports this information and raw observations are being logged at the reference.
	Not known	The real-time message format does not support this information or the information is not yet received by the rover.
	None	Raw observations are not being logged at the reference.

Next step
CONT (F1) exits STATUS Logging.

24.1.5 Occupation Information Status

Description

This screen shows information related to the amount of time required at a point and the amount of time spent on a point.

Access

Step	Description
1.	Press USER to access GPS1200 User Menu .
2.	Press STAT (F3) to access STATUS Status Menu .
3.	Select Survey...Occupation Information Status .

STATUS Occupation Infor- mation (Static); STATUS Occupation Infor- mation (Moving)

Available for logging of raw observations. The name of the screen changes with the static or moving mode of the receiver. The values are reset with each new static interval. Information on this screen is available for **<R-Time Mode: None>** and **<R-Time Mode: Rover>**.

For static mode

Description of fields

Field	Description
<Obs Completed:>	The percentage of collected data required for successful processing. It is a conservative estimate based on a 10 - 15 km baseline. The criteria used to display this value depend on the settings for <Auto STOP:> , <STOP Criteria:> and <% Indicator:> in Main Menu: Config...Point Occupation Settings .
<Time to Go:>	The estimated time in hours, minutes and seconds until the configured criteria for <STOP Criteria:> or <% Indicator:> is reached. The criteria used to display this value depend on the settings for <Auto STOP:> , <STOP Criteria:> and <% Indicator:> in Main Menu: Config...Point Occupation Settings .
<Time at Point:>	The time passed since OCUPY was pressed in the SURVEY screen.
<Cycle Slips L1/L2:>	The number of cycle slips on L1 and L2 that have occurred since recording started on the current point.
<Obs Rec Rate:>	Rate at which raw observations are being recorded.
<Static Obs>	The number of logged static raw observations. Reset as soon as a new static interval starts.

For moving mode

Description of fields

Field	Description
<>5 Sats Since:>	The time for how long five or more satellites are tracked on L1 and L2 without interruption. The counter is reset if less than five satellites were tracked. The counter is not reset after OCUPY (F1) , STOP (F1) or STORE (F1) .
<GDOP:>	Current GDOP.
<Obs Rec Rate:>	Rate at which raw observations are being recorded.
<Moving Obs:>	The number of logged moving raw observations. Reset as soon a new moving interval starts.

Next step

CONT (F1) exits **STATUS Occupation Information (Static)** or **STATUS Occupation Information (Moving)**.

24.2 STATUS: Battery & Memory

Access

Step	Description
1.	Press USER to access GPS1200 User Menu .
2.	Press STAT (F3) to access STATUS Status Menu .
3.	Select Battery & Memory .

STATUS Battery & Memory (Rover), Battery page



Battery A : 36%
Battery B : 100%
Battery Ext A: not attached
Backup Bat : OK



CONT (F1)

To exit **STATUS Battery & Memory (Rover)**.

REF (F5)

Available when the receiver is configured as real-time rover. To view battery and memory information for the reference.

Description of fields

Field	Description
Any field	The percentage of remaining power capacity for all batteries numerically. Batteries not in use are shown in grey.

Next step

PAGE (F6) changes to the **Memory** page.

STATUS Battery & Memory (Rover), Memory page

If no information for a field is available, for example no CompactFlash card is inserted, then ----- is displayed.

Description of fields

Field	Description
<Device Used:>	The memory device in use.
<Mem CF Card:>	The total/free memory for data storage on the CompactFlash card.
<Mem Instrmnt:>	The total/free memory for data storage in the internal memory. A grey field and grey dashes indicate an unavailable internal memory.
<Mem Programs:>	The total/free system memory used for application programs.

Field	Description
<Mem System:>	The total/free system memory. The system memory stores <ul style="list-style-type: none"> • receiver related files such as system settings. • survey related files such as codelists and configuration sets.

Next step

IF	THEN
the receiver is a real-time rover	REF (F5) shows battery and memory information for the real-time reference in use.
the receiver is not a real-time rover	CONT (F1) exits STATUS Battery & Memory (Rover) .

STATUS Battery & Memory (Reference)

This screen consists of the **Battery** and the **Memory** page. Both pages are similar to those of the rover screen. The information that is displayed depends on the real-time message.

Leica: Transfers precise values for all fields.
RTCM: Transfer of any of the information not part of the message.
CMR/CMR+: Transfers general status information such as O.K. and Low.

Next step

CONT (F1) returns to **STATUS Battery & Memory (Rover)**.

24.3 STATUS: System Information

Access

Step	Description
1.	Press USER to access GPS1200 User Menu .
2.	Press STAT (F3) to access STATUS Status Menu .
3.	Select System Information .

STATUS System Information, Instrument page

Shows the type of receiver, the serial number, the equipment number, the ID of the receiver, the currently active system language, the serial number of the measurement engine, the availability of additional instrument hardware options such as event input, L2C, Multipath Mitigation, GLONASS ready, GLONASS permanent and if the protected OWI commands have been activated by a licence key.

Next step

PAGE (F6) changes to the **Firmware** page.

STATUS System Information, Firmware page

Shows the versions of all system firmware.

Description of fields

Field	Description
<Firmware:>	The firmware version of the onboard software.
<Build:>	The build version of the firmware.
<Maintenance End:>	The expiry date of the contract is shown.
<Meas Engine:>	The firmware version for the measurement engine.
<Meas Eng Boot:>	The firmware version of the boot software for the measurement engine.
<Boot:>	The firmware version of the boot software.
<LB2/OWI:>	The firmware version for the communication.
<Navigation:>	The navigation firmware version with the algorithms for the signal processing.
<API:>	The firmware version for the application program interface.
<EF Interface:>	The firmware version for the electric front interface.

Next step

PAGE (F6) changes to the **Application** page.

STATUS System Information, Application page

Shows the versions of all uploaded application programs.

Next step

CONT (F1) exits **STATUS System Information**.

24.4 STATUS: Interfaces...

Description

This screen shows information about incoming data from the following interfaces/devices:

- **Real-Time Input**
- **ASCII Input**
- **Tilt**
- **Meteo**
- **Event Input**
- **Internet**
- **Remote Interfaces**
- **Bluetooth**



The options **Tilt** and **Meteo** are not available for RX1250 with SmartAntenna.

Access

Step	Description
1.	Press USER to access GPS1200 User Menu .
2.	Press STAT (F3) to access STATUS Status Menu .
3.	Select Interfaces...
4.	Highlight an interface.
5.	IFACE (F5)
	DEVCE (F5) to view information about the device attached to the interface.

Next step

CONT (F1) exits **STATUS XX**.

STATUS SmartAntenna Interface (XX)

This screen is accessible for a configured SmartAntenna interface. This is possible for RX1250 with SmartAntenna.

The way information is displayed indicates the configuration and connection status of the SmartAntenna.

Information displayed	SmartAntenna configured	SmartAntenna connected
in black	x	x
in grey	x	-
as -----	-	-

STATUS Bluetooth

The way information is displayed indicates the configuration status of the Bluetooth port and the connection status of the device.

Information displayed	Bluetooth port configured	Device connected
in black	x	x
in grey	x	-
as -----	-	-

25.1 Overview

Description

Networked Transport of RTCM via Internet Protocol

- is a protocol streaming real-time corrections over the Internet.
 - is a generic protocol based on the Hypertext Transfer Protocol HTTP/1.1.
 - is used to send differential correction data or other kinds of streaming data to stationary or mobile users over the Internet, allowing simultaneous PC, laptop, PDA, or receiver connections to a broadcasting host.
 - supports wireless Internet access through mobile IP networks like digital cellular phones or modems.
-

System components

NTRIP consists of three system components:

- NTRIP Clients
- NTRIP Servers
- NTRIP Caster

Refer to the GPS1200 Technical Reference Manual for more information about NTRIP.

25.2 Configuring a Real-Time Rover for Using NTRIP Service

25.2.1 Configuring an Access to the Internet

Requirements

- Firmware v1.5 or higher must be loaded on the GPS1200 receiver.
- Firmware v1.42 or higher must be loaded on the RX1200.



A GPRS device can be connected in a clip-on-housing or with RX1250 via Bluetooth.

Configure access to Internet step-by-step

Step	Description
1.	Select Main Menu: Config...Interfaces...
2.	In CONFIGURE Interfaces highlight Internet .
3.	EDIT (F3) to access CONFIGURE Internet Interface .
4.	CONFIGURE Internet Interface <Internet: Yes:> <IP Address: Dynamic> <User ID:> Some providers ask for a user ID to allow connecting to the Internet via GPRS. Contact your provider if a user ID needs to be used. <Password:> Some providers ask for a password to allow connecting to the Internet via GPRS. Contact your provider if a password needs to be used.
5.	DEVCE (F5) to access CONFIGURE GPRS Internet Device .
6.	CONFIGURE GPRS Internet Devices Highlight the GPRS / Internet device to be used.
	NEW (F2) to create a new GPRS / Internet device.
	SRCH (F4) Available on RX1250 with <Port: Bluetooth x> and a Bluetooth device being selected. To search for all available Bluetooth devices. If more than one Bluetooth device is found a list of available devices is provided.
7.	CONT (F1) to return to CONFIGURE Internet Interfaces .
8.	CONT (F1) to return to CONFIGURE Interfaces .
9.	CTRL (F4) to access CONFIGURE GPRS/Internet Connection .
10.	CONFIGURE GPRS/Internet Connection <APN:> Available for some devices. The Access Point Name of a server from the network provider, which allows access to data services. Contact your provider to get the correct APN. Mandatory for using GPRS.
	CODES (F3) Available for digital cellular phones of GSM technology. To enter the Personal Identification Number of the SIM card. If the PIN is locked for any reason, for example the wrong PIN was entered, input the Personal Unblock ing code for access to the PIN.
11.	CONT (F1) to return to GPS1200 Main Menu .

Step	Description
	The receiver is now online to the Internet. The Internet online status icon is displayed. But because GPRS is being used, no charges are yet made since no data transfer from the Internet has yet taken place.
12.	USER
13.	STAT (F3) to access STATUS Status Menu .
14.	Highlight Interfaces...
15.	ENTER to access STATUS Interfaces .
16.	STATUS Interfaces Highlight Internet .
17.	IFACE (F3) to access STATUS Ethernet .
18.	STATUS Ethernet
19.	Check the Internet online status.
20.	CONT (F1) to return to STATUS Interfaces .
21.	CONT (F1) to return to GPS1200 Main Menu .

25.2.2 Configuring to Connect to a Server

Requirements

The configurations from the previous chapter must have been completed. Refer to "25.2.1 Configuring an Access to the Internet".

Configure connect to a server step-by-step

Step	Description
1.	Select Main Menu: Config...Interfaces...
2.	CONFIGURE Interfaces Highlight Real-Time .
3.	EDIT (F3) to access CONFIGURE Real-Time Mode .
4.	CONFIGURE Real-Time Mode <R-Time Mode: Rover> <R-Time Data:> Select the type of data to be received from the Internet. <Port: NETx>
5.	CONT (F1) to return to CONFIGURE Interfaces .
6.	Highlight Real-Time .
7.	CTRL (F4) to access CONFIGURE Set NET Port .
8.	CONFIGURE Set NET Port <User: Client> <Server:> The server to be accessed in the Internet. Opening the choicelist accesses CONFIGURE Server to Connect where new servers can be created or existing servers can be selected or edited. <IP Address:> The IP address of the server to be accessed in the Internet. <TCP/IP Port:> The port of the Internet server through which the data is provided. Each server has several ports for various services. <Auto CONEC: Yes> Allows for automatic connection between the rover and the Internet when a point is occupied during a survey. Ending the point occupation also ends the Internet connection.
9.	CONT (F1) to return to CONFIGURE Interfaces .
	Once the receiver is connected to the server a message is displayed in the message line.
10.	CONT (F1) to return to GPS1200 Main Menu .
11.	USER
12.	STAT (F3) to access STATUS Status Menu .
13.	Highlight Interfaces...
14.	ENTER to access STATUS Interfaces .
15.	STATUS Interfaces Highlight Real-Time .
16.	DEVCE (F5) to access STATUS Device: Internet .

Step	Description
17.	STATUS Device: Internet Check the Internet online status.
18.	CONT (F1) to return to STATUS Interfaces .
19.	CONT (F1) to return to GPS1200 Main Menu .



25.2.3 Using the NTRIP Service with a Real-Time Rover

Requirements

The configurations from the previous chapter must have been completed. Refer to "25.2.2 Configuring to Connect to a Server".

Use NTRIP service step-by-step

Step	Description
1.	Select Main Menu: Config...Interfaces...
2.	In CONFIGURE Interfaces highlight Real-Time .
3.	EDIT (F3) to access CONFIGURE Real-Time Mode .
4.	CONFIGURE Real-Time Mode <Port: NETx> must be selected.
5.	ROVER (F2) to access CONFIGURE Additional Rover Options .
6.	PAGE (F6) to access CONFIGURE Additional Rover Options, NTRIP page.
7.	CONFIGURE Additional Rover Options, NTRIP page
8.	<Use NTRIP: Yes> <User ID:> A userID is required to receive data from to the NTRIP Caster. Contact the NTRIP administrator for information. <Password:> A password is required to receive data from the NTRIP Caster. Contact the NTRIP administrator for information.
9.	SRCE (F5) to access CONFIGURE NTRIP Source-Table .
10.	CONFIGURE NTRIP Source-Table All MountPoints are listed. MountPoints are the NTRIP Servers sending out real-time data. This screen consists of two columns: <ul style="list-style-type: none"> • First column MountPoint: The abbreviations for the MountPoints. • Second column Identifier: The city where the MountPoint is located.
11.	Highlight a MountPoint about which more information is required. This information helps to configure the receiver to use the selected MountPoint as a reference.
12.	INFO (F3) to access CONFIGURE MountPoint: XX .
13.	CONFIGURE MountPoint: XX, General page <Format:> The real-time data format sent out by the MountPoint. <FormatDet:> Details about <Format:>, for example the RTCM message types including update rates in seconds displayed in brackets. <Authentic:> The type of password protection required for the authorisation to the NTRIP Server. <Authentic: None> if no password is required. <Authentic: Basic> if the password need not be encrypted. <Authentic: Digest> if the password must be encrypted. <NMEA:> Indicates if the MountPoint must receive GGA NMEA data from the rover in order to compute VRS information.

Step	Description
	<p><Charges:> Indicates if charges are currently made for the connection.</p> <p><Carrier:> The type of carrier phase information in the data stream.</p> <p><System:> The type of satellite system supported by the MountPoint.</p>
14.	PAGE (F6) to access CONFIGURE MountPoint: XX, Location page.
15.	<p>CONFIGURE MountPoint: XX, Location page</p> <p>Detailed information about the location of the MountPoint is displayed.</p>
16.	PAGE (F6) to access CONFIGURE MountPoint: XX, Miscell page.
17.	<p>CONFIGURE MountPoint: XX, Miscell page</p> <p><Generator:> The hard- or software generating the data stream.</p> <p><Compress:> The name of the compression / encryption algorithm.</p> <p><Info:> Miscellaneous information if available.</p>
	PREV (F2) to display information about the previous MountPoint in the list.
	NEXT (F3) to display information about the next MountPoint in the list.
18.	CONT (F1) to return to CONFIGURE NTRIP Source-Table .
19.	CONT (F1) to return to CONFIGURE Additional Rover Options .
	SHIFT CONEC (F3) and SHIFT DISCO (F3) are now available in all applications to connect to and disconnect from the NTRIP Server.

Menu tree

MAIN MENU

- SURVEY
- PROGRAMS...
- MANAGE...
 - JOBS
 - DATA
 - |— CODELISTS
 - |— COORDINATE SYSTEMS
 - |— CONFIGURATION SETS
 - ANTENNAS
- CONVERT...
 - |— EXPORT DATA FROM JOB
 - |— EXPORT ASCII
 - |— IMPORT DATA TO JOB
 - |— IMPORT ASCII/DXF
 - |— DXF IMPORT
 - |— COPY POINTS BETWEEN JOBS
- CONFIG...
 - |— SURVEY SETTINGS...
 - |— ID TEMPLATES
 - |— DISPLAY SETTINGS
 - |— CODING & LINEWORK SETTINGS
 - |— QUALITY CONTROL SETTINGS
 - |— LOGGING OF RAW OBS
 - |— POINT OCCUPATION SETTINGS
 - |— SEISMIC RECORDING
 - |— RING BUFFER, not for RX1250 with SmartAntenna
 - |— INSTRUMENT SETTINGS...
 - |— ANTENNA & ANTENNA HEIGHTS
 - |— SATELLITE SETTINGS
 - |— TIME ZONE
 - |— INSTRUMENT ID
 - |— SET NET PARAMETERS, GRX1200 Pro/GRX1200 GG Pro
 - |— GENERAL SETTINGS...
 - |— WIZARD MODE
 - |— HOT KEYS & USER MENU
 - |— UNITS & FORMATS
 - |— LANGUAGE
 - |— DISPLAY, BEEPS, TEXT
 - |— START UP & POWER DOWN, GX1200/GRX1200

- |— START UP, for RX1250 with SmartAntenna
- |— INTERFACES...
 - |— REAL-TIME
 - |— ASCII INPUT
 - |— NMEA OUT 1
 - |— NMEA OUT 2, not for RX1250 with SmartAntenna
 - |— EXPORT JOB
 - |— HIDDEN PT
 - |— TILT, not for RX1250 with SmartAntenna
 - |— METEO, not for RX1250 with SmartAntenna
 - |— SMARTANTENNA, for RX1250 with SmartAntenna
 - |— INTERNET, not for GRX1200 Pro/GRX1200 GG Pro
 - |— PPS OUTPUT, GX1200 with PPS/GRX1200 Pro/GRX1200 GG Pro
 - |— EVENT INPUT, GX1200 with Event/GRX1200 Pro/GRX1200 GG Pro
 - |— EXT OSC, GX1200
 - |— ASCII REMOTE
 - |— REMOTE
- |— TOOLS...
 - |— FORMAT MEMORY DEVICE
 - |— TRANSFER OBJECTS...
 - |— CODELISTS
 - |— CONFIGURATION SETS
 - |— COORDINATE SYSTEMS
 - |— GEOID FIELD FILES
 - |— CSCS FIELD FILES
 - |— FORMAT FILES
 - |— JOBS, if internal memory is fitted
 - |— SYSTEM RAM CONTENTS
 - |— MODEM/GSM STATIONS
 - |— IP HOSTS
 - |— ANTENNA RECORDS
 - |— PZ-90-TRANSFORMATION
 - |— UPLOAD SYSTEM FILES...
 - |— APPLICATION PROGRAMS
 - |— SYSTEM LANGUAGES
 - |— INSTRUMENT FIRMWARE
 - |— CALCULATOR
 - |— FILE VIEWER
 - |— LICENCE KEYS

Index

A		B	
Absolute coordinate difference		Battery	13
Display	53	Icon	17
Limit exceeded	53	Status	191
Absolute difference between two points	52	Beep	125
Access, MANAGE XX	39	Bluetooth	13
ACCNT	180	Icon	16
Activate		Identification number	161
Code filter	61	C	
Code group	64	Calculator	174
Adapter	29	CAPS	7
Add point to line	57	Carrier	29
Angle, display format	121	CE	7
Antenna	113	Choicelist	12
Create	86	Close	
Edit	86	Area	40
Recall deleted default	41	Line	40
Set default height	113	CMND	160
Antenna height, determine	29	CMR/CMR+, data format	133
Antennas		Code	
Default	85	Create	64
Reset default settings	41	Edit	64
aNUM	126	Code filter for lines and areas	61
Application programs memory, format	171	Code group	
Area	13	View, create, delete, activate, deactivate	64
Close	40	Code type, set	65
Create	56	Codelist	
Edit	56	Create	63
Icon	16	Edit	63
Open	40	Management	63
Area code, filter	61	Codes, sort	
Area management	55	Codelist management	64
Areas, sorting and filters	59	Data management	61
Arrow keys, right/left	12	Coding	103
ASCII	93	CompactFlash card	13
ATCMD	156	Icon	16
Attribute, type in new	64	Configuration set	
Attributes, symbol	19	Create	82
Average	52	Default	81
Limit, exceeded	53	Description	81
Averaging	52	Edit	83
Configure	46	Recall deleted default	41
Include/exclude coordinate triplet	52	Turn into user defined default	40
Averaging mode, define	52	User defined	81

Configuration set wizard	81	D	
Configuration sets		Data	47
Reset default settings	41	Export	89
Configure		Directory	90
Clip-On interface	35	Import	93
SmartAntenna interface	34	Logged, view	40
Connect equipment and ports	21	Data format, real-time	133
Contrast, screen	125	Data log	40
Coordinate system	73	Data management	47
Create	74	Date, local	116
Edit	74	Deactivate	
Turn into user defined default	40	Code filter	61
Coordinate systems		Code group	64
Recall deleted default	41	Default	
Coordinate types, display	48	Recall deleted	
Copy points between jobs	97	Antenna	41
Create		Configuration set	41
Antenna	86	Coordinate system	41
Area	56	Devices	154
Code	64	Settings in display mask	102
Code group	64	Delete	
Codelist	63	Area	40
Configuration set	82	Code group	64
CSCS model	79	Coordinate triplet	53
Ellipsoid	77	Geoid/CSCS model	79
Geoid model	79	Line	40
Job	44	Observation files automatically	107
Line	56	Option in MANAGE	39
Point	48	Point from line	58
Projection	77	DEVICE	154
Transformation	77	Device	153
CSCS model	79	Create	156
Create from CompactFlash card	79	Description	129
Create from internal memory	79	Edit	156
CTRL		Devices	
GSM	159	Access CONFIGURE	154
CTS	157	Configuration	153
Current position, status	184	Control	159
Cut off angle	114	Digital cellular phone, icon	14
		Dimensions, carrier and adapter	29
		Display	125
		Settings	101
		Display coordinate types	48
		DMASK	101
		Documentation	2
		DXF	93

E		F	
EAO, configure	147	File Viewer	174
Edit		FILES	106
Antenna	86	FILT	40
Area	56	Height smoothing	138
Code	64	Filter	
Codelist	63	Activate/deactivate for codes	61
Configuration set	83	Point, line and area codes	61
Coordinate system	74	Points in Stakeout application program	59
Ellipsoid	77	Points, lines and areas	59
ID template	100	Symbol	19
Job	44	Filter settings, define	40
Line	56	Firmware, version	193
Measured coordinate triplet	53	Format	
Option	39	Export	89
Point	48	Import	93
Projection	77	Format file, export ASCII	89
Transformation	77	Format memory device	171
Value in input field	11	Formats	121
EGNOS, real-time data format	139	Frequency, change for radio	163
Elevation mask	114	Front panel	21
Ellipsoid management, access	76	G	
Ellipsoid, create/edit	77	General settings	119
Ellipsoids	76	Geoid model	79
End date	57	Create from CompactFlash card	79
End time	57	Create from internal memory	79
ENTER	8	GGA, key	144
Equipment setup	21	Graph, showing satellites	178
ESC	7	GROUP	64
European Geostationary		GS16	93
Navigation Overlay Service	139	GS18	93
Exceeded limit		H	
Absolute coordinate difference	53	Heating, screen	125
Average	53	Height filter	138
DOP	105	Height mode	77
Exclude coordinate triplet from averaging	52	Height smoothing	138
Expiry date, software maintenance	193	Height, pole	30
Export		HEALTH	114
ASCII Data	90	Hidden point, interface	146
Format	89	Hot keys, configure	120
EXPRT	45		

I	
Icons	13
ID	47
ID template	99
Create	100
Delete	100
Edit	100
Identification number	117
Bluetooth	161
IFACE	
Data export	90
Status	194
Illumination	
Keyboard	125
Screen	125
Import	
Data	94
Format	93
IMPRT	45
Include coordinate triplet in averaging	52
Increase point ID	100
Increasing NE, SE, SW, NW	122
Incrementation, point ID's	100
Instrument ID	117
Instrument settings	113
Interface	
Remote port	21
User	7
Interface, description	129
Interfaces... ..	129
Interfaces..., status	194
Internal memory	13
Icon	16
Internet online status	13
Icon	15
Internet, interface	151
INTL	40
J	
Job	43
Create	44
Edit	44

K	
Keyboard	7, 10
Illumination	125
Lock and unlock	10
Keys	7
Alpha	7
Arrow	8
Combinations	8
Function	7
Hot	7
Numeric	7
L	
Language	
Select	124
Upload	173
Left, arrow key	12
Leica software	
Access	31
Activate	31
Exit	31
Minimise	31
Leica, data format	133
Length	57
LGO	
Download, jobs	43
Upload, jobs	43
Licence key	175
Limit, exceeded	
Absolute coordinate difference	53
Average	53
Symbol	19
Line	
Close	40
Create	56
Edit	56
Icon	16
Open	40
Line code, filter	61
Line management	55
Line style	
Coding	65
New line	57
Lines, sorting and filters	59
Linework	67
LIST	119

Local		O	
Date	116	Object, description	47
Time	116	Occupation information, status	189
Lock, keyboard	10	Offset	
LOG	44	Antenna, input	86
Log raw observations	106	Antenna, vertical	30
Logged data, view	40	External angle	147
Logging status	186	Hidden point measurements	147
M		ON	7
MANAGE XX, access	39	Open	
Manage..., getting started	39	Area	40
Management		Line	40
Antennas	85	Oscillator, external, icon	13
Area	55	OWI commands, status	193
Codelists	63	P	
Configuration sets	81	Page down	8
Coordinate systems	73	Page up	8
Data	47	Personal Identification Number	
Getting started	39	GSM	160
Jobs	43	Receiver	37, 127
Line	55	Pillar setup	29
Points	48	PIN	160
Mean page	52	GSM	160
Access	52	Receiver	127
Mechanical reference plane	29	Point	
Memory, status	191	Add to line	57
Menu tree	203	Create	48
Menu, select from	10	Delete from line	58
MORE	40	Edit	48
MountPoint	200	Point code, filter	61
MRP	29	Point ID, incrementation	100
MSAS, real-time data format	139	Point management	48
MTSAT		Point occupation settings	108
Satellite-based Augmentation System	139	Points	
N		Copy between jobs	97
New version, upload	173	Sorting and filters	59
New, create option	39	Points filter, Stakeout application program	59
NTRIP	195	Pole	
Number of satellites, used in solution	179	Height	30
		Setup	30
		Ports	
		Connect equipment	21
		Description	129
		On receiver front panel	21
		Position mode	13
		Icon	15
		Position status, icon	13

Power down	127	RTCM	
PRED	138	Data format	134
Prediction	138	V3	134
PRN	178	RTS	157
PROG	7	RX1200	
PROGS	171	Control key beep	126
Projection management, access	76	Exchange	125
Projection, create/edit	77	With/without touch screen	2
Projections	76	S	
Protection by PIN/PUK	37	S/N	178
Pseudo Random Noise	178	Satellite status	177
Q		Satellites	
Quick access to screens, configure	120	Contributing	13
Quick coding	13	Health	114
Icon	17	Icon	13, 14
R		Number used in solution	179
Radio		Settings	114
Change channels	163	Visible	13
Icon	14	SBAS	133, 138
Radio down, log raw observations	106	Key	143
Radio Link Protocol	161	Screen	9
Raw observations, log	106	Contrast	125
Real-time	131	Heating	125
Status	179	Illumination	125
Real-time device	13	Select from menu	10
Icon	14	Serial number	193
Real-time status	13	SET-D	40
Icon	14	Setup	21
Recall		Post-processed	
Default attribute values	50	Reference on pillar	22
Default display mask	102	Real-time reference	
Deleted default		Single tripod	23
Antennas	41	SmartAntenna + RX1250	24
Configuration set	41	Real-time rover	
Coordinate system	41	All-on-pole	28
Devices	154	Pole and minipack	26
Last used attribute values	50	SmartRover, external radio	25
Remote interface, port	21	SHIFT	8, 13
Remove, point from line	58	Icon	17
Reset, default antenna settings	41	Signal to noise ratio	178
Residual, largest, symbol	19	Skyplot	178
Right, arrow key	12	Smoothing heights	138
RLP	161	Software upload	173
RT-1	137		
RT-2	133		

Sort	
Codes	
Codelist management	64
Data management	61
Points, line and areas	59
Sort settings, define	40
SPACE	8
Space-Based Augmentation System	133, 138
Staked out, symbol	19
Stakeout, filter points	59
Start date	57
Start time	57
Start up	127
STAT	177
Status	177
OWI commands	193
Position	13
Survey Settings...	99
Survey..., status	177
SV health	114
Switching, Leica software and Windows CE	31
Symbols	19
System information, status	193
SYSTEM	171
T	
Text	125
Time slicing	135
Time zone	116
Time, local	116
Touch screen	10
On, off	125
Transfer objects	172
Transformation management, access	76
Transformation model	78
Transformation, create/edit	77
Transformations	76
Tripod setup	30
U	
Units	121
Unlock, keyboard	10
Upload, system files	173
USER	8
User interface	7
User menu, configuration	120
V	
Value, edit in input field	11
VERS	180
Versions of system firmware	193
Vertical offset, antenna	30
View	
Code group	64
Geoid model	79
Logged data	40
Points, lines, areas, free code	
Stored in job	40
W	
WAAS, real-time data format	139
Wake-up sessions, symbol	19
Wide Area Augmentation System	139
Wildcard	60
Windows CE desktop, access	31
Windows CE, activate	31
Windows key symbol	7, 8, 31
Wizard	119

Total Quality Management: Our commitment to total customer satisfaction.



Leica Geosystems AG, Heerbrugg, Switzerland, has been certified as being equipped with a quality system which meets the International Standards of Quality Management and Quality Systems (ISO standard 9001) and Environmental Management Systems (ISO standard 14001).

Ask your local Leica Geosystems dealer for more information about our TQM program.

733504-5.0.0en
Original text
Printed in Switzerland © 2006 Leica Geosystems AG, Heerbrugg, Switzerland

Leica Geosystems AG
Heinrich-Wild-Strasse
CH-9435 Heerbrugg
Switzerland
Phone +41 71 727 31 31
www.leica-geosystems.com

- when it has to be **right**

Leica
Geosystems